

An Adventure for use with

STAR TREK™

THE ROLE PLAYING GAME

WITNESS FOR THE DEFENSE



fasa

An Adventure for use with

STAR TREKTM
THE ROLE PLAYING GAME

WITNESS

FOR THE DEFENSE



An adventure scenario for STAR TREK: The Role Playing Game

By Guy W. McLimore, Jr.
Fantasimulation Associates

Janus VI design by Guy W. McLimore, Jr. Maps and other art by Mitchell O'Connell and Dana Knutson

Graphic Design: Dana Knutson and Mitch O'Connell

Copyright © 1966, 1983 Paramount Pictures Corporation
All Rights Reserved
Printed in the United States of America

STAR TREK is a trademark of Paramount Pictures Corporation
STAR TREK The Role Playing Game is published by FASA Corporation under exclusive license from Paramount Pictures Corporation, the trademark owner.

No part of this book or the contents of the basic game may be reproduced in any form, or by any means without permission in writing from the publisher.

Manufactured by Patch Press, Inc.

Published by FASA Corporation
P.O. Box 6930
Chicago, Illinois
60608-6930

Table of Contents

Adventure Requirements	5
Beginning the Adventure.	6
Arrival at Janus VI.	8
Captain Kirk and Judicial Impartiality.	9
Involving the Players	9
Encounters on the Tour	10
After the Tour - First Day.	13
Character Sheets	15-16 and 24-25
Janus VI layout and floor plans	17-23
Other Investigations.	26
Gamemaster Information	32
The Murder of Louis Handy	32
Searching the Tunnels	33
Aftermath	34
Vehicle Specifications	35
Character Statistics	37
Janus VI Mining Colony	38
Main Building.	38
Main Cavern Facilities	39
Other Areas of Interest.	39
The Horta	39

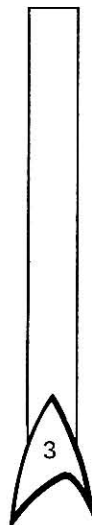

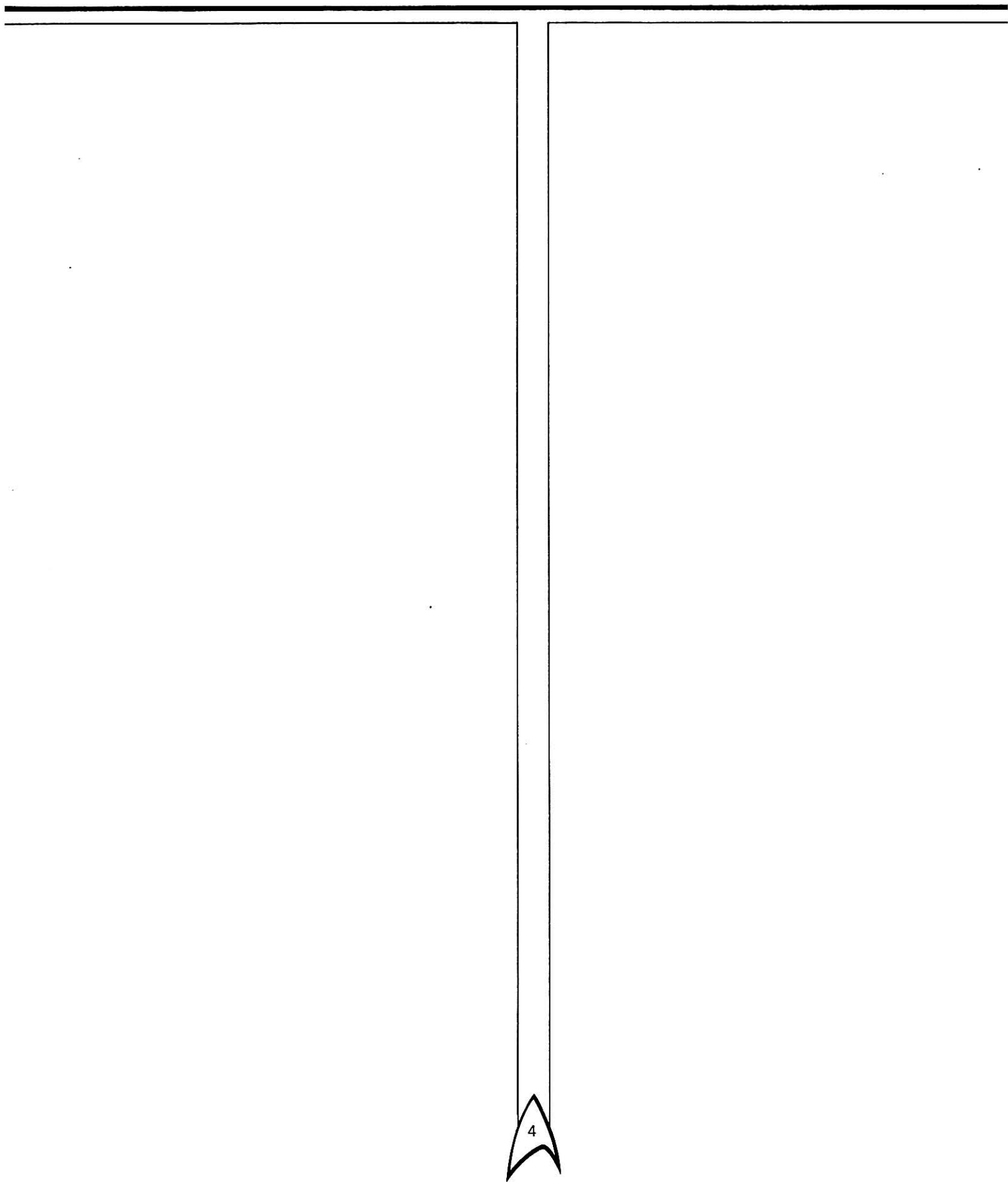

Adventure Requirements

This adventure is designed to be used with the crew of the U.S.S. Enterprise during the latter part of its five-year mission (at any time following the events of the live-action TV series). It would also be possible to use a variation of this adventure in campaign settings featuring another Constitution class starship, or other larger Federation vessel. Doing so, however, will require some work by the gamemaster to provide new clues and sources of information for the player characters.

Much of the "plot" for this adventure scenario involves the intervention of familiar Enterprise characters, and specialized knowledge possessed by them because of their involvement in the events chronicled as the television episode, "The Devil in the Dark". Thus, the designers recommend, especially for less experienced gamemasters, that the scenario be used with the Enterprise characters.

For those not familiar with the STAR TREK episode, "The Devil in the Dark", a synopsis of the plotline is provided at the end of the adventure. This should be read by a gamemaster who is not familiar with the episode. Likewise, the synopsis should be provided to the gamers playing Kirk, Spock, McCoy and Scotty if they are not already familiar with it. If not playing the Enterprise crew, the synopsis should NOT be provided unless Star Fleet records of the Enterprise's earlier visit to Janus VI are retrieved from the ship's computer.

Also helpful to the gamemaster will be the Bantam Books STAR TREK Fotonovel of the episode, and relevant entries in the STAR TREK CONCORDANCE by Bjo Trimble, if they are available.

Beginning the Adventure

The following message should be provided to the ship's communications officer or captain:

FROM: Star Fleet Legal Services
Adm. C. Taplin
TO: U.S.S. Enterprise
Capt. J. Kirk, commanding

In pursuance with Star Fleet regulation 5782, paragraph A, U.S.S. Enterprise is requested to divert course to Hyrallis IV to pick up Star Fleet Legal Services officer Lt. L. Delaney. U.S.S. Enterprise is then to proceed to Janus VI Pergium Production Station and assist local authority in conducting investigation and preliminary hearings on local legal matters. As provided for the regulation 5782, paragraph G, starship commander is empowered to act in the name of the Federation to adjudicate felony matters when so requested by local authority over Federation citizenry.

Requested by local authority (W. Vanderburg, Chief Engineer) Stardate 8941.4, Janus VI).

A private note is appended to the official communication, as follows:

Jim: Sorry to stick you with this, but only a man of your rank is empowered to act as a "frontier judge" under these circumstances. Hope this won't tie the Enterprise up for too long. Lunch next time you're in port?
Clem

When the Enterprise receives the message it is two days away from Hyrallis IV at warp 3. There is no particular urgency specified in the message, so the Captain may proceed at any speed desired.

Upon arrival and checking in with planetary authorities, Lt. Laura Delaney will request permission to come aboard. She will do so somewhat impatiently, unless the Enterprise made the trip faster than warp 3. If the ship is early, Lt. Delaney knows little about the case she has been assigned to, and will not feel justified in discussing it at length anyway. (She will most definitely NOT discuss it with the captain, as he will be acting as judge at the hearing -- though she will be glad to converse with the captain and crew on other subjects.) She will inform them that it is her understanding that they are being asked to hear a murder case, and that her client is a young miner accused of killing his partner.

If the Enterprise is not being used, Lt. Delaney can act as a source of information on the Janus VI colony, since she has received a full briefing on the subject. In this way, the players and their characters can be introduced to the information in the next section involving the colony structure and background.

Delaney was very anxious to be picked up, but will not be in such a hurry to get to Janus VI. Hyrallis IV, her

last assignment, was a very small colony world with little in the way of legal reference material. Once aboard the Enterprise, she will make full use of the ship's vast computer legal library and other sources to research her case. Janus VI is 2 weeks away at warp 3, which would be standard cruising speed.

About 1 week later, as the Enterprise passes the half-way point, a second message is received, as follows:

FROM: Star Fleet Legal Services
Adm. C. Taplin
TO: U.S.S. Enterprise
Capt. J. Kirk, commanding

Once again, a personal message is attached:

Jim: It's hit the fan, I'm afraid. This one is best done quickly, and without undue fuss. The locals have bungled it, but Star Fleet will have to take the rap. I can't say more, but I hope you'll forgive me for dropping it in your lap. That lunch when you get here is on me.
Clem

By proceeding at warp 5, the Enterprise can be at Janus VI in just over a day and a half.



The Janus VI situation has become top priority. Local officials request immediate assistance. Non human relations endangered, necessitating haste. Enterprise requested to proceed at warp 5 to Janus VI and provide legal assistance and prisoner transport. Details on arrival.

BACKGROUND—JANUS VI PERGIUM PRODUCTION STATION

DESIGNER'S NOTE: The information in this section is what would be found in Lt. Delaney's briefing notes on Janus VI, or in the Enterprise library computer files. If the players request such information, or parts of it, from either source, give them only what they specifically ask for. More detailed information can only be obtained on Janus VI itself, by interviewing the miners and other residents.

The Janus VI facility is owned and operated by an employee held corporation. Such corporations are just beginning to become a force in interstellar trade and industry, taking business in some areas away from large planetary and multistellar corporations.

Each miner and staff member at the facility is also a stockholder. Unlike workers who are merely employees, every miner in Janus VI's caverns has paid for the privilege of working there by buying stock in the corporation. Only the medical officer and sales agent are truly employees and thus not required to buy stock.

Miners who buy in then work the mines. They are paid a living wage for hourly work, but the lucrative part are shares of stock given for meeting or exceeding personal production quotas. These shares of stock pay dividends when the pergium is sold (mostly to the Federation itself, or to planetary governments and private corporations).

The shares themselves have a cash value, but they can not be sold on the open market (though they can be transferred to another stockholder). If a miner does not maintain a minimum number of shares, he cannot remain and earn more. Of course, the more shares one owns, the more dividends one earns.

Corporations of this type allow a large number of individuals to pool their money and found corporations capable of competing with the huge multistellar conglomerates. There is a long waiting list for "buying into" the Janus VI corporation. The corporation is chartered by the Federation, but qualifies as an independent colony under Federation law. Thus, local administrative personnel have precedence, but may call upon the Federation for aid and services.

In the case of Janus VI, the top local official is Chief Engineer Wilson Vanderburg, himself a miner (though no longer active on that capacity) who is one of the largest stockholders of the corporation. His assistant, Ed Appel, is not as experienced, but is well liked among the men and is trusted by Vanderburg. A sales agent and medical officer are employed by the corporation. A bit over 100 people are currently residents of the colony.

Miners do not usually bring families to Janus VI as conditions are rather austere. Most of the miners are either young men planning to spend a few months or years building a nest egg, or older men with no families.

The surface of Janus VI itself is uninhabitable, due to high winds, corrosive atmosphere, and dust storms. All colony facilities are underground. It is only on such worlds where pergium deposits are found. A heavily shielded and automated transporter repeater station has been installed on the surface so that transport operations can take place directly between orbiting ships and the underground

mining colony.

Pergium is most commonly used as fuel for certain types of nuclear reactions. The unrefined substance itself is not dangerous, and no particularly unusual safety precautions must be taken in handling it. Once refined, however, a small amount of pergium can run a pergium reactor and produce power far more efficiently (and with much less shielding) than uranium or plutonium. Pergium reactors are not used on starships, because they are most efficient in low-yield situations. They are used on many planets where small self-contained colonies are set up. With the state of galactic expansion as it is, there is always a ready market for pergium, and Janus VI is particularly rich in the material.

Miners on Janus VI use phaser heating units built into heavy mining vehicles to separate pergium from rock and prerule it. The prerule material is then transferred to a small, fast vehicle for transport to the prerule storage. (See drawings and descriptions of these special vehicles at the end of this section.)

Prerule pergium is then refined by a number of heat and chemically induced processes, and stored until it can be beamed up for transport and sale on other worlds. The refining process is completely automated.

Janus VI is unique among pergium processing facilities for another reason -- the Horta. The Horta are an intelligent race native to Janus VI with a unique silicon -- based metabolism. An adult Horta resembles a large, mobile hunk of partially molten rock. Horta have sense organs approximating humanoid sight and hearing, but no manipulatory appendages. All horta can excrete a powerful corrosive agent, capable of burning through most known materials almost instantly. An adult is capable of manipulating his corrosive spray with great precision for tunnelling through rock, or even to the extent of cutting fine grooves in rock or metal. It is also used as a defensive weapon. (See description and statistics on the Horta in the basic game rules under "New Life and New Civilizations--Animal Lists".)

Horta are extraordinarily longlived, with a lifespan of about 60,000 years. After such a time, the entire generation of a Horta colony dies at about the same time, leaving one individual to tend the eggs and raise the next generation that the Janus VI miners happened on groups of Horta eggs. Believing them to be just a natural silicon nodule formation, the miners destroyed many before the single adult Horta began to fight back, killing almost half of the mining force.

Eventually, the matter was settled when the crew of the U.S.S. Enterprise discovered that the Horta was an intelligent creature. After a mindlink with Enterprise First Officer Spock, the adult Horta agreed to aid the miners and train the young hatchlings, when they arrived, in doing the same. In return, the miners would protect the Horta eggs and allow the Horta to tunnel.

The agreement thus concluded promises to increase the productivity of the Janus VI station many times over. The Horta eggs have already begun hatching, but the long-lived Horta are not mature enough for mining (or unsupervised travel in areas also occupied by humans and mining equipment) for a number of years. In the meantime, arrangements have been made to protect the Horta young (and to protect the colony FROM the Horta young...).

Arrival at Janus VI

When the Enterprise approaches Janus VI, it will be hailed by Assistant Chief Engineer Ed Appel, who will invite Lt. Delaney, Captain Kirk, and any senior officers who wish to accompany them to beam down. The presence of Mr. Spock and Dr. McCoy will be encouraged, but Appel will not explain the reasons for his request, saying that he prefers that the landing party talk with the chief engineer and himself in person and in private.

The Janus VI station, being far underground, is served by a surface-mounted transporter signal repeater station. The repeater station is as close to absolutely foolproof as is possible. Thus, no special modifiers are applied for beaming to the station's receiving area.

The use of shuttles on Janus VI is completely impractical, due to the winds and dust storms. No shuttle could hope to survive a landing attempt. The miners themselves do not even attempt to go onto the surface. Even the infrequent service calls on the transporter repeater are done by specially equipped service ship crews that call periodically.

Vanderburg and Appel will meet the landing party at the transporter area of the station's main building. The transporter platform is a new addition since Kirk and his crew were here last, and Appel will probably comment on it. He will explain that it was added recently to handle the greater flow of transporter traffic at the station since the Horta incident. Both Vanderburg and Appel will be reluctant to discuss anything involving the case until the group is led to Vanderburg's office and the door is closed.

Once settled in Vanderburg's office, Vanderburg and Appel will give the following basic explanation of the situation. The gamemaster may read this information just as it is written, but should be prepared to supplement it with conversation or to answer specific questions from the Enterprise personnel. (Lt. Delaney will not ask questions at this time, but will wait until the end of this discussion and then ask Appel for a private appointment to discuss the case later.)

VANDERBURG: (After the usual exchange of pleasantries, offering of seats, etc.) We're very pleased you could come for this, Captain. Frankly, we've just seen this whole thing escalate into something with implications we just can't handle alone. This is really Ed's baby, now -- he made all the arrangements -- so I suppose he should explain it. Ed...?

APPEL: Will's handed me the administrative end of this mess, since by colonial law the chief administrative officer of a colony -- and in our case that's Will -- must act as prosecuting officer in a felony case when a colony is too small to have it's own legal officials.

VANDERBURG: Don't envy me too much, Ed. I wish I could trade places with you.

APPEL: No thanks! In this case, I'm all too happy NOT to have your job. In any case, this whole thing started with the death of one of our miners, an old timer by name of Louis Handy. At first it looked like an accident with one of our mining machines, but a cursory examination of

the evidence led to the conclusion that someone had murdered Handy and tried to make it look like an accident. We didn't have to look far for a suspect, since...

VANDERBURG: (interrupting) Hold on, Ed. The captain has to hear this case. Let's not prejudice it by presenting evidence to him in an informal situation!

APPEL: (apologetically) Sorry. You're right, of course. Let's just say that we had a suspect -- Jack Katz, one of Handy's partners -- and we put him "under arrest", or as close to it as we could come under these circumstances. (Appel pauses, looking upset.) Maybe what happened later was my fault, Captain. I had Katz confined to his quarter and gave orders that he wasn't to leave the building. There is only one way in or out and Jack hadn't offered any resistance. The fact remains, however, that Jack left his quarters and somehow got out of the main building.

We put together a search party and found him soon thereafter, but we also found something else... (His voice trails off.)

VANDERBURG: The horta -- the adult one, that is... I'm afraid she's dead.

(This is likely to cause the players quite a bit of consternation, especially Kirk and McCoy, if they are playing their roles well.)

VANDERBURG: (continuing) She was found in one of the old tunnels. One of the processing vehicles with the scoop removed was nearby.

APPEL: (interrupting) We use these vehicles to melt rock and process the pergium. They have banks of phaser heat units. Handy was killed by one.

VANDERBURG: Right. Anyway, the phaser heaters were apparently turned on the Horta when she came through the corridor. Unlike a standard hand phaser, these units are pre-set for silicon structure. She never had a chance against massed fire like that.

At this point, Lt. Delaney will ask if her client is to be charged with both crimes. Vanderburg and Appel will confirm it. Delaney will then ask to see her client. She will not at this time take any other characters with her to the interview, but afterward, she will discuss the interview and the case with any player who seems sympathetic to the case (except Cap. Kirk, who must not discuss the case with ANYONE.) Vanderburg will inform those present that the company's charter prohibits the use of the psychotricorder for criminal matters as well. Thus, the truth will have to be found without the use of this handy device.

While Lt. Delaney is interviewing the accused miner, Vanderburg and Appel will offer the hospitality of the station to the officers present, and suggest that any crewmen who wish to tour the station may make arrangements to do so during off duty hours. All officers will have to

sleep aboard ship during the stay, as quarters at the station are filled to capacity. Vanderburg or Appel will explain how the news of the Horta cooperation has brought miners from all over, and there is now a long waiting list -- all this despite the fact that half the mining crew was killed in the original misunderstanding with the Horta. Once the briefing is concluded and Lt. Delaney has left, crewmen may talk to the miners, look over the station's facilities, etc., whenever they are off duty.

CAPTAIN KIRK AND JUDICIAL IMPARTIALITY

The player who represents Capt. Kirk has the problem of maintaining impartiality. Since he must, under Federation law, not discuss or hear testimony involving the case outside the courtroom, Kirk will find his presence in groups at the station may stifle important exchanges of information. The Kirk player must be careful to guide his officers without actually supporting either side of the action before the court. This will require good role playing by the Kirk player.

At first glance, the Kirk player seems to be left out of things. This is, to some extent true -- intentionally so. In STAR TREK adventuring using the U.S.S. Enterprise, Kirk often dominates a situation. This adventure is designed to spotlight other officers and limit Kirk's role in controlling the situation. The Kirk player, if he is careful, can still exert a lot of influence if he plays cleverly.

Though Kirk must remain impartial, he is known to be an opinionated individual who is motivated by a strong sense of justice. Thus, he would not be unsympathetic to attempts by his officers to help Lt. Delaney OR Chief Engineer Vanderburg investigate the case. The Kirk player -- while he cannot investigate on his own -- can use his position to help the other officers do so. Kirk can allow a player-character officer to shift his duty schedule, allowing time off to help the investigators. He can also allow the use of ship's equipment and facilities for such purposes. In this way, Kirk can be the guiding force he was intended to be, without hogging all the action.

If a Kirk player fails to maintain some distance between the case and himself, the gamemaster must remind him of his duty. If the player starts actively investigating or otherwise interfering in a manner that is not in keeping with his judicial role, he may bring protests from Vanderburg, Lt. Delaney, or BOTH. Such protests should allow the gamemaster to keep Kirk at a distance, but still involved through interaction with his officers.

Of course, officers who involve themselves in the case must not discuss their findings with the Captain. (In practice, it is usually all right to let the Kirk player stay in the room during investigations. He would hear most of it through the grapevine anyway.) This actually presents players with a marvelous opportunity to help onside or the other in ways which might not be exactly according to "the book". After all, the Captain can't say no to an idea if he isn't asked, and the players always have the excuse later that "we didn't want to prejudice the case by discussing it, sir..." How well this tactic works depends on whether or not top officers like Spock and Scotty can be convinced to join (or at least be sympathetic to) an unofficial investigation effort by player-character officers.



INVOLVING THE PLAYERS

Obviously, the adventure will not be much fun unless the players themselves become involved in the action. The informal nature of frontier justice (combined with the colony's inexperience in such matters) make it possible for the player characters to take sides in the matter and work to help (or accidentally hinder) the investigation.

The players can be drawn into the action through use of certain non player characters in accidental or planned meetings. These should take place during the time Lt. Delaney is interviewing her client, and soon thereafter.

The officers who beam down for the initial briefing should be escorted on a tour of the station's main building by Appel right after Delaney leaves. Vanderburg will stay in his office to prepare the prosecution's case after sending Delaney off with one miner as escort and guide. Players who wish to remain and question him may do so. They do not go on the tour, but will be exposed to the information under Vanderburg's name in the section on RUMORS, OPINIONS AND TESTIMONY.

The gamemaster, playing the role of Appel, should conduct the tour using the floor plans of the building. (He will not conduct them into the main cavern installations or the tunnels, though groups which wish to go will have miner guides assigned at a latter time.

Use the floor plan descriptions and cavern map descriptions to conduct the tour and indicate what persons will be met along the way. During this first look, certain non player characters may be encountered. These encounters are described in the section below. Note that if Captain Kirk is along on the tour, the non players -- once introduced by Appel -- may be reluctant to discuss the case with him. Those that are NOT reluctant may cause a problem for Kirk, who must try and remain impartial. The gamemaster should by all means, allow the players' interests to dictate how the tour proceeds. If the player characters express no interest in an area, Appel will make the stop brief, or pass it by all together. In this way, the players might miss an important contact or clue, but it is their choice. Don't force anything on them.

Encounters on the Tour

The tour should probably start with the Chief and Assistant Chief Engineer's offices themselves, along with the shared reception room. All three rooms have one glass wall with a great view of the main cavern level. Appel will show the players the view, with the gamemaster using the cavern map to point out most of the landmarks. If players express interest in further exploration of these areas, Appel will assign a miner as a guide after the building tour.

Unless the interests of the players lead them elsewhere, Appel will then show them the Sales Agent's office, recreation room, one of the locker rooms (for the men), geology lab, pergium testing lab, and dispensary. The tour of this level will end with a short visit to the VIP office, now occupied by Lt. Solon. Appel will then take the group to the turbolift and down all the way to the power plant level.

The following encounters can happen on this level, depending on the player's reactions. If the players show little interest in an area, give only a little information or perhaps none at all. If the players hang around a bit, give them more. Appel is conducting what he expects to be a short, snappy tour. He will not rush the players along, but neither will he linger where the players are not obviously interested in staying.

SALES AGENT: Sales agent Davidson Leek told him last month that a couple of the large mining concerns were really putting on the pressure, but that Leek says they are running scared because of the Horta cooperation. Appel will then look sad and say "Who knows what will happen with all that now."

RECREATION ROOM: As described, with a few miners here playing pool, and another group around a card table. Appel will not introduce anyone unless specifically asked to do so. These miners are not important non-players, but just average residents of Janus VI. Most of them, if engaged in conversation, are sorry to see Jack Katz in so much trouble, but they think he's guilty. One or two, however, are very angry about the whole thing, and would just as soon see Katz dumped on the planet's surface without an environmental suit. They are newer miners, who came after the news of the Horta, and are sure that the "easy money" died with the Horta.

LOCKER ROOM: The miners are all men on Janus VI, so if female officers are present, Appel won't stop here. If asked about the lack of female miners, Appel will be a bit embarrassed. "That's what Doc Levine's always been down on us about," he will explain. Appel will claim that the mining colony started as a small operation and grew more swiftly than was expected. He claims there is no official policy forbidding female applicants, but no one has ever gotten around to providing facilities for them. If the players press the subject, Appel will suggest they talk to Dr. Levine, the only woman resident on the station since it's her favorite subject of conversation. He will then change the subject.

GEOLOGY LAB: This lab is pretty well the private domain of Dr. Klaus Wagner, the Chief Geologist. Dr. Wagner will be here and be introduced by Appel. Wagner is

amused by the title "Chief Geologist" as he is the ONLY full-time geologist employed at the station. If the players engage him in conversation, he will claim he has little enough to do now that the mine is established. The formations and content thereof are pretty well understood, with few surprises. If further discussion takes place, he will mention that he amuses himself with whatever anomalies he can find in samples taken. Right now, he is mildly amused by some crystalline structures found here and there that seem resistant to corrosives like Horta acid. He speculates that there might even be major deposits of the material somewhere, though he admits none have yet been found. As it is, the samples he has are very small. "Too bad, really," Wagner will say. "This stuff could be very useful in quantity for lots of scientific and engineering applications."

PERGIUM TESTING LAB: This lab is empty right now, only used for testing samples from each batch of pergium before shipping. Dr. Wagner runs this lab as well.

DISPENSARY: The player-character officers may be surprised to find that the station's medical officer is an attractive woman the only female at the station. As predicted by Appel, Dr. Levine has no qualms about discussing her feelings about the all-male nature of the station.

If the players talk to her for very long, she will come across as truly fond of her job and of the people here, even though she disapproves of the all-male (and mostly human) composition of the work force.

"It's the nature of groups like employee-owned corporations to be inherently conservative," explains Dr. Levine. "The first miners were male and human, and they subconsciously favor applications from male humans when it comes time to screen new applicants." Levine admires and respects Vanderburg, but considers him too set in his ways. She and Appel have a bantering relationship which players used to Spock/McCoy conflicts might find familiar. They obviously like and respect each other, but can't help teasing and baiting each other, particularly about the all-male nature of the station.

Dr. Levine, if conversed with at length, will reveal that she had a great deal of trouble being accepted by the all-male crew. She has been here eight months, and only recently has felt that the miners have grown used to her presence. "At first, there was hostility," she explains, "followed later by more propositions than an Orion dancer gets on a shore leave planet." Dr. Levine keeps her personal life from her work, but those who watch closely may get the idea that there is potential for more to develop between her and Appel.

If Dr. McCoy is present, Dr. Levine will be very anxious to talk to him, and will suggest that they meet after the tour for lunch. (She will suggest one of the mess rooms on the living levels, though she will accept an invitation from McCoy for lunch aboard the Enterprise if he suggests it. As Dr. Levine is an attractive woman, McCoy's player is a bit out of character if he DOESN'T suggest it.)

Dr. Levine signed the death certificates for both the dead miner and the Horta. The body of Louis Handy is

in the medical storage room in a special refrigerated locker, ready to be shipped back to his family. The Horta's body was not moved, and still remains in the tunnel where the Horta died. Guards have been placed around. Chosen by Vanderburg and Appel from volunteers among the miners. "That nice, Randy Conway then volunteered," Dr. Levine will say (if asked about the guards), "but Wilson -- Mr. Vanderburg, that is excused him from the job because of his friendship with Handy. He didn't want Conway to be exposed to a reminder of his friend's passing." If questioned further about Conway, she will profess to know little about him, and will suggest the officers talk to Conway himself.

V.I.P. OFFICE: This office has been assigned to Lt. Solon, a Vulcan, who has been assigned here on detached duty from Star Fleet by the UFP Diplomatic Corps.

Appel will introduce Solon to the officers, and explain that Solon was assigned as an inter-species liaison between the miners and the Horta. Solon is a highly trained psionic interpreter, whose job is to use Vulcan mind touch techniques to make contact with species incapable of communicating effectively otherwise with humans and human/Vulcan-like beings like most Federation member cultures.

Solon will be a bit embarrassed if Spock is present, but of course as a Vulcan, Solon will not show his embarrassment as is natural.

Solon, if asked, will explain that he has only arrived recently -- two weeks before the first murder -- and was still making preliminary observations of his subject when the Horta was killed. Thus, he never made mental contact with the Horta.

Before the players leave, and if Spock is present, Solon will stop Spock at the door and quietly ask him to set up a meeting between Solon and Captain Kirk -- a meeting which Spock would attend as well. Solon will not discuss the meeting or why he wants it, but asks that it be soon -- this afternoon if possible. If Spock denies the request because he does not wish to prejudice the case, Solon will claim the meeting has nothing to do with the case itself, and be insistent that a meeting is important.

Solon would prefer to meet aboard the Enterprise, and asks Spock not to discuss his request with anyone but Captain Kirk.

Once the encounter with Lt. Solon is finished, Appel will take the players to the turbolift and down to the power plant level.

POWER REACTOR ROOM: Kirk, Spock, and Scotty would remember this room. It is from here that the Horta stole a pergium reactor circulating pump, threatening the safety of the entire station. The Horta later gave it back, after mind-touching with Spock.

The reactor in use is still the old P XK pergium reactor used during the Enterprise's earlier visit. Appel will explain that there were plans to replace it with something new in the near future. Appel will also assure Scotty that they have "laid in a couple of replacement pumps, just in case..."

STORAGE ROOMS: There is nothing unusual about these rooms, so Appel will not linger here. There is a spot on the floor near the frozen food lockers where one has obviously been detached and removed. It is now up in the medical storage room, holding Louis Handy's body. The pergium fuel storage area is, of course, locked up and

heavily radiation shielded.

Next, Appel will take the group up to the engineering level. Upon arrival on the level, Appel will say "There's a lot of machinery down here, but let me show you something we're very proud of..." He will then take them down to the pool/sun deck room.

POOL/SUN DECK: As described in the floor plan elaborations. Several miners are here, swimming or sunning. A young miner waves from the diving board as Appel and the group enter and makes a perfect, precise dive. Appel and the other miners applaud, and Appel motions for the miner to swim over and be introduced.

The diver is miner Randy Conway, who Appel will introduce as the dead miner's partner and best friend. Conway is friendly and seems genuinely pleased to see the Enterprise people. He expresses his desire to see his friend's murderer brought to justice, but seems to bear no particular ill will toward his other partner, Jack Katz, who is accused of the crime.

If questioned, he will say this about the situation: "Jack and Louis didn't get along. To tell the truth, Louis was a hard man to understand, until you got past the exterior unfriendliness. He had a lot of problems, but we seemed to hit it off pretty well once he realized I was not out to give him any trouble. But he and Jack went at it all the time. I never thought it would come to something like this, though..."

Appel and the other miners seem to like Conway and trust him. For Conway's part, he will go out of his way to be friendly to the Enterprise officers whenever he encounters them. Here, he will take over the job of describing the pool and sun deck area to the visitors. Appel will explain how Conway used to spend a lot of time here until "Handy got his crazy ideas..."

If pressed about the crazy ideas, Conway will say the following: Well, Louis thought some of the played out tunnels still might contain enough pergium to be worth reopening. I helped him work them for awhile, but with Jack being assigned to us as our new work partner, it seemed unfair to stick him with something as unfruitful as that. I was trying to talk Louis out of that wild goose chase, as a matter of fact. Louis has kept us so busy looking for something that isn't there, that I haven't had any time for diving, or tunnel running or anything else."

Appel will explain that Conway, despite his relatively short time here, has become a first class tunnel car driver, and has even "hopped up" his own vehicle. The conversation here can continue on a friendly basis for awhile before the players and Appel move on.

OTHER ROOMS: There will be no other encounters on this level, and Appel will not waste a lot of time here. He will show the visitors the hydroponics room, the engineering room, and the miner's equipment storage area before returning to the turbolift and moving up to one of the living levels.

LIVING AREA: On one of the living levels, Appel will explain that there are four such levels, with miners from one shift mostly living on the same level. All the miners quarters are occupied, but Appel briefly shows the group his own quarters, explaining that miners live in shared quarters that are almost as big. He moved when he was made Assistant Chief Engineer only because Vanderburg insisted.



MESS ROOM: Appel will end the tour in the mess room on that floor. Since this shift is in its sleep period, he will be surprised to find one miner -- Ralph Antara -- is here drinking coffee. When Antara is introduced, he will be quite excited, and will insist that the Enterprise people must help him clear his friend Jack Katz. Antara is convinced Katz is innocent, and will be very interested in telling the Enterprise people how his friend just couldn't have done this terrible thing. Finally, Appel will suggest the group leave, and will apologize down on main floor for Antara's behavior. Appel will then return to duty, after summoning miners to guide anyone who wishes to sightsee elsewhere.

AFTER THE TOUR -- FIRST DAY

After the tour, it will be about noon. Dr. McCoy will probably wish to meet with Dr. Levine, and Spock may wish to speak with Captain Kirk about Solon's request. (If Spock does not do something about the request right away, Solon will send a message to Kirk directly, asking to speak with him immediately.) The information gathered from these meetings will be discussed in this section.

One other person has meanwhile requested a meeting with Kirk -- Lt. Delaney. Since the business Delaney wishes to discuss is within his function as judge, he should probably see her first. This exchange is also covered in this section.

Other player characters may wish to do some investigating on their own. If they wish to speak to the accused, they will have to go through both Delaney and Appel, and have a pretty good reason. Talking to anyone else, however, is just a matter of tracking them down, which in most cases will be easy. If players are going to investigate anywhere besides the main building, they must have a miner assigned as a guide, such arrangements being made by Appel.

If players want to interview someone (besides the ones noted above) on the first day (day of arrival), check out the next section, which discusses the story each person will tell, as well as the things that can be learned from records or by examining things in various areas of the station.

Discussions with Dr. Levine: Dr. Levine will meet with Dr. McCoy in the prearranged place for lunch, as agreed. If he is alone, she will feel free to talk with no reservations because she feels less inhibited talking to a colleague in the medical profession. If others come along, she may hesitate at times, as noted in the discussion below.

Over lunch, Dr. Levine will tell McCoy that she is very glad the Enterprise was the ship to respond to this call. This is because of McCoy's experience with the Horta in the past. It was Dr. Levine who had to examine the dead Horta and sign the death certificate. Ever since, she has been worried that she may have missed something important that might bear on the case.

Dr. Levine has become acquainted with the young miner Jack Katz, who is accused of both murders. She thinks of him as a "nice young man" who is unlikely to be a murderer. She wants to enlist McCoy's help to gather such evidence, starting with asking him to examine both the dead Horta and the dead miner.

If McCoy agrees, Dr. Levine will suggest that they get started right away, and will conduct him to the site of the Horta's slaying. They will travel by tunnel runner (the small mining vehicle used by all miners to get around fast -- see the vehicle descriptions at the end of the adventure...) to the site, which is in the southwest section of the tunnel complex.

Travel by tunnel runner is fast and easy -- if the driver is experienced in the operation of the vehicle. Someone without much ground vehicle experience could drive one, but not very fast. Dr. Levine will point this out politely to Dr. McCoy when she drives out to the site of the Horta's death.

There is a miner standing guard with a hand phaser nearby, but he will simply greet Dr. Levine and allow the vehicle to pass. Levine will explain that she's come out here several times since the incident, but hasn't really known what to look for.

Upon arrival, the two medical officers will find a very dead member of the Horta species. Most of the outer rock--like covering on the front has been blasted away, and even the greyish flesh itself has been burned away in several spots.

Dr. Levine will tell McCoy that she has studied the tapes he made after his first successful attempt at Horta medicine, using thermo concrete to patch a wound. The injuries here would have been too extensive for such treatment, even had the Horta still been alive when Dr. Levine was summoned.

The "murder weapon" itself is nearby -- a "sizzle bug" mining vehicle with its front scoop removed and the phaser heating units turned up to full power. (Since McCoy is probably not familiar with the vehicle, Dr. Levine will explain the basics of how it works, following the description in the vehicles section. If Dr. McCoy needs more technical information, the guard could be called over, as he is a miner and has operated these vehicles before.)

Dr. Levine will say that Vanderburg believes the killing was an ambush, with the killer sitting behind the controls at the crossing of tunnels and blasting the Horta when it approached. Jack Katz, after leaving custody, was later found in this general area just after the Horta's death was discovered.

If McCoy examines the dead Horta, the gamemaster should make a secret saving roll for him on his INT attribute. If he makes the save, he will notice that the "patch" of thermo-concrete he placed to heal the Horta's earlier wound, is not present. (If McCoy specifically says he wishes to examine the old wound, he will notice this with no saving roll required.)

The missing "patch" will no doubt raise McCoy's suspicions. If McCoy shows this to Dr. Levine, she will be surer than ever that something is very wrong with the evidence. She will suggest that they return to her office, where she can call up pictures of the murder scene and other pictures of the mother Horta taken earlier. If McCoy agrees, they will leave immediately.

Back at Dr. Levine's office, the pictures will reveal that that dead Horta has different markings than the one "healed" by McCoy years earlier. They are unmistakably NOT the same individual! This difference in markings would not be immediately apparent, even to someone who saw the Horta every day. (Let's face it one Horta does look

just about like any other Horta, especially since NO ONE has ever seen any adult Horta but the original...)

This information should be communicated to Vanderburg, Delaney and Captain Kirk immediately.

Lt. Solon's report: The Vulcan psionic interpreter has filed a report with the Federation Diplomatic Corps by subspace radio, and will discuss it with Captain Kirk and Mr. Spock at the meeting he has requested. Privately, Solon will reveal that he has recommended that the Federation revoke the charter of the Janus VI corporation and have the colony evacuated.

He has made this recommendation upon logical examination of the facts surrounding the murder. With the adult Horta gone, there is no Horta to teach the young Horta how to behave and interact safely with the mining colony. For now, the young remain in "the Playpen", a force-screened enclosure provided by the colony so the mother Horta could leave her brood unattended for awhile. The miners have been providing rock for the young to feed upon, since they cannot tunnel within the enclosure.

Solon will point out that the Horta young are too immature to learn how to live with the colony -- too young even for mind contact to be an effective teaching method. (Nor could Solon mind contact enough of the young to make a difference, even if it did work...) Without training, the hundreds of young Horta would tunnel indiscriminately, endangering miners and themselves. Also, more eggs hatch each week, making the problem more acute all the time.

It is Solon's opinion -- which is likely to be upheld by the diplomatic corps and the Federation Council that the only way the Federation can avoid causing the extinction of the Horta race is to remove the colony, and allow the young to run free until they grow up (a process which takes many years...). The young Hortas can feed and take care of themselves if the dangerous implements of the colony are removed, and the planet is placed under Federation quarantine for their protection. Moving the Hortas, or delaying the release of the Horta young, is an unacceptable alternative which Interference Directive.

He brings the matter to Captain Kirk, because Kirk as a starship captain with wide discretionary powers can order the colony's operations shut down until the matter is settled, and can use his starship to back up the decision of the diplomats when it is made. Solon expects a reply to his report within 4 days, and wants Captain Kirk to enforce it. (Kirk, of course, will be legally bound to do this anyway.)

Solon has not mentioned his report to anyone, fearing that the miners would become unruly if the contents of the report were made public. Solon suggests, however, that Kirk must finish the trial before the reply comes in, for if the colony is closed all evidence will be unavailable for a later trial.

The Vulcan lieutenant, of course, bears no malice toward the miners. He has simply taken the logical course and followed his duty. That will not, however, make it any easier for the miners.

Lt. Delaney's request: Lt. Delaney will report to captain Kirk after her interview with her client. (Whether

this happens before or after the meeting with Lt. Solon depends on how quickly Spock arranged the meeting. Delaney will report about two hours after the tour is completed, so if the meeting happened right away, Kirk has already heard from Solon.)

She will of course not discuss the conversation with Captain Kirk, but she wishes to ask for a continuance, giving her "a week or so" to further investigate and prepare a defense. She notes that the colony has made no in depth investigation, and that the case against her client is circumstantial only. Lt. Delaney requests the aid of the Enterprise security force to complete a thorough examination of the evidence before a trial, along with the help of the Enterprise medical division in forensic investigations of both victims. (She is, at this time, unaware of Dr. McCoy's examination...)

Kirk may be sympathetic to her request, which in ordinary circumstances would be reasonable. But he also has Solon's report to deal with (though Kirk may not know it yet...). It is up to the Kirk player to decide this issue based on what he knows, and what he is prepared to deal with.

If Kirk denies the continuance, he may or may not tell Lt. Delaney about Solon's report. His decision will be further complicated by Dr. Levine and Dr. McCoy's report, which will reach him either while Delaney is meeting with Kirk or soon after.

Once Kirk has heard from Solon, McCoy and Delaney, the issue will be so thoroughly muddled that he will be forced to delay the trial and call a special hearing (probably for the following morning) to inquire about Dr. McCoy's findings. If Kirk does not do this on his own, the gamemaster (speaking through Delaney or Dr. Levine, or a non-player Enterprise character) should suggest this to him. At any rate, the gamemaster should require Kirk to tell Solon, Vanderburg, Appel, and Delaney of the discovery.

Solon, upon hearing of McCoy's discovery, will point out that the presence of a previously unsuspected SECOND adult Horta changes everything. The first Horta cannot be dead, and Kirk must make an effort to discover it's whereabouts. Solon will offer to pass the news along to his superiors, but will refrain from doing so if requested by Kirk to hold the information back.

Vanderburg will also ask Kirk to help search for the Horta, and offer to turn out all shifts of miners to aid the search. Appel will agree to this.

Lt. Delaney (taking loopholes where she finds them) will inform Kirk that the case of mistaken identity makes the Horta charge incorrect on it's face, and request additional time to prepare a case and inspect the new evidence, since the charges on the Horta murder must be revised.

All of this hoopla leaves Kirk squarely in the middle. Unless Kirk SPECIFICALLY orders all parties to keep the information a secret, the miners will all know about the mistaken identity of the Horta by morning.

If Kirk keeps the information under wraps, he will at the very least have to delay the trial. If security forces are ordered to aid the investigation, miners will begin to get suspicious and rumors will fly. Despite Kirk's best efforts, if there is any sort of visible evidence of a new investigation, rumors of it will get around to all the miners by noon.

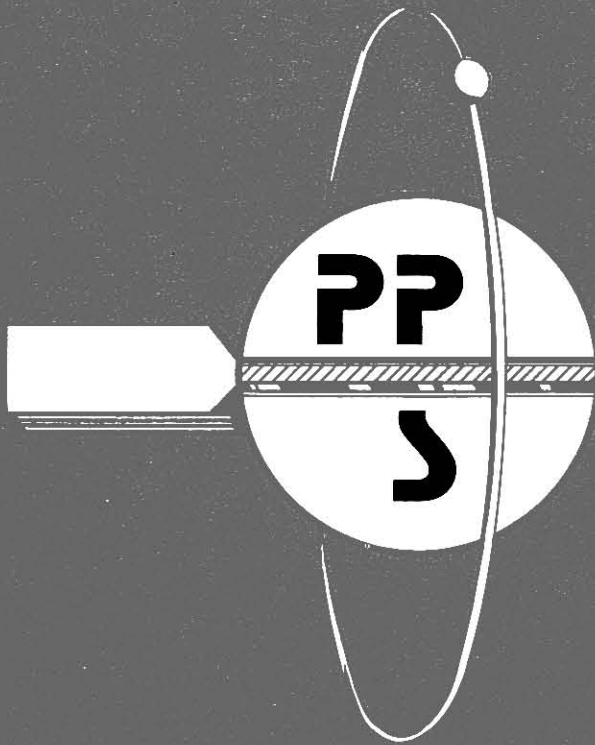

CHARACTER Vanderberg, Wilson	
PLAYER	
RANK	AGE 62
RACE Human	SEX M
CURRENT ASSIGNMENT	
Chief Engineer—Pergium Production Station—Janus VI	
SPECIALIZATION AREA	
Mining Engineer/administrator	
Marksmanship (modern)	25
To Hit Modern	34
Personal Combat (unarmed)	21
To Hit H-T-H	32

STR 58	END 39	INT 57	DEX 44	CHA 63	LUC 59	PSI 08
---------------	---------------	---------------	---------------	---------------	---------------	---------------

Administration 63	Mechanical Eng. 41	Starship Sensors _____
Atmosphere Craft Pilot. _____	Medicine _____	Starship Services _____
Astron./Astroph. _____	Negot./Diplomacy 38	Streetwise 39
Botany _____	Personal Wpn. Tech 25	Trans. Op. Proc. _____
Carousing. 34	Prs. Comb. (Ar.) _____	Trans. Systems Tech _____
Commun. Sys. Tech. _____	Physical Chem. _____	Vocal Music _____
Comp. Arch. _____	Physics _____	Trivia _____
Computer Operation 29	Planetary Ecology 16	Water Vehicle Op. _____
Computer Tech. _____	Planetary Survival _____	Warp Drive Tech. _____
Def. Shield Tech _____	Psych. _____	Zero-G Operations. _____
Electronics Tech 16	Rac. Clt./His. _____	Zoology. _____
Env. Suit Operations _____	Ship's Weaponry Tech _____	Mining _____ 88
Federation History _____	Shuttlecraft Pilot. _____	_____
Federation Law. 34	Shutt. Sys. Tech _____	_____
Gaming 22	Sm. Eq. Sys. Tech _____	_____
Geology. 86	Small Unit Tactics. _____	_____
Grav. Veh. Operation _____	St. Cmbt. Tac./Str. _____	_____
Instruction. 13	St. Comm. Proc. _____	_____
Inst. Music _____	St. Comm. Proc. _____	_____
Lang. _____	St. Engrg. (General). _____	_____
Leadership 77	Starship Helm Op _____	_____
Life Sup. Tech 29	Starship Navigation _____	_____
Marks (Arch.) _____	Starship Security. _____	_____

18
17
16
15
14
13
12
11
10
9
8
7
6
5
4
3
2
1

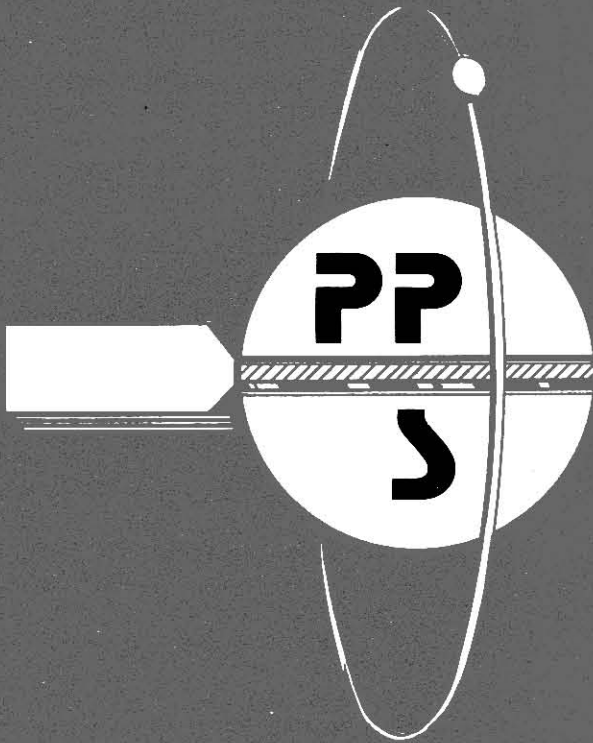

CHARACTER	Appel, Ed	
PLAYER		
RANK	AGE	35
RACE	Human	SEX M
CURRENT ASSIGNMENT		
Asst. Chief Engineer—Pergium		
Production Station Janus VI		
SPECIALIZATION AREA		
Miner		
Marksmanship (modern)	61	
To Hit Modern		
Personal Combat (unarmed)	38	
To Hit H-T-H		

18
17
16
15
14
13
12
11
10
9
8
7
6
5
4
3
2
1

STR 66	END 62	INT 61	DEX 77	CHA 51	LUC 43	PSI 01
---------------	---------------	---------------	---------------	---------------	---------------	---------------

Administration 19	Mechanical Eng. 28	Starship Sensors _____
Atmosphere Craft Pilot. _____	Medicine _____	Starship Services _____
Astron./Astroph. _____	Negot./Diplomacy 16	Streetwise 22
Botany _____	Personal Wpn. Tech 58	Trans. Op. Proc. _____
Carousing. 11	Prs. Comb. (Ar.) _____	Trans. Systems Tech _____
Commun. Sys. Tech. _____	Physical Chem. _____	Vocal Music _____
Comp. Arch. _____	Physics _____	Trivia _____
Computer Operation 38	Planetary Ecology 31	Water Vehicle Op. _____
Computer Tech. _____	Planetary Survival 14	Warp Drive Tech. _____
Def. Shield Tech _____	Psych. _____	Zero-G Operations. _____
Electronics Tech _____	Rac. Clt./His. _____	Zoology. _____
Env. Suit Operations _____	Ship's Weaponry Tech _____	Mining _____ 76
Federation History _____	Shuttlecraft Pilot. _____	_____
Federation Law. 9	Shutt. Sys. Tech _____	_____
Gaming 13	Sm. Eq. Sys. Tech _____	_____
Geology. 59	Small Unit Tactics _____	_____
Grav. Veh. Operation _____	St. Cmbt. Tac./Str. _____	_____
Instruction. 5	St. Comm. Proc. _____	_____
Inst. Music _____	St. Comm. Proc. _____	_____
Lang. _____	St. Engrg. (General) _____	_____
Leadership 51	Starship Helm Op _____	_____
Life Sup. Tech 12	Starship Navigation _____	_____
Marks (Arch.) _____	Starship Security. _____	_____

GAME MASTER'S MAP

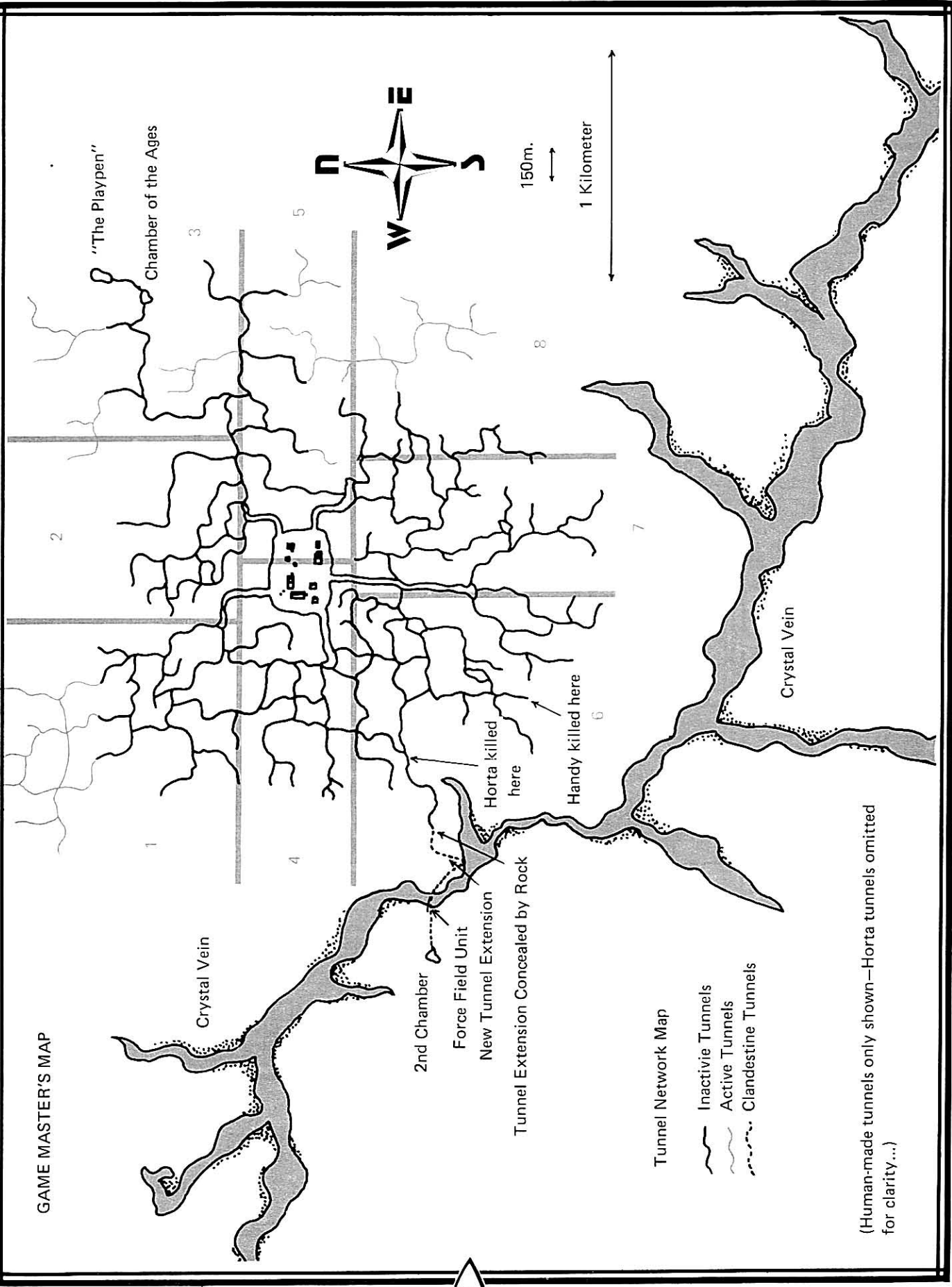



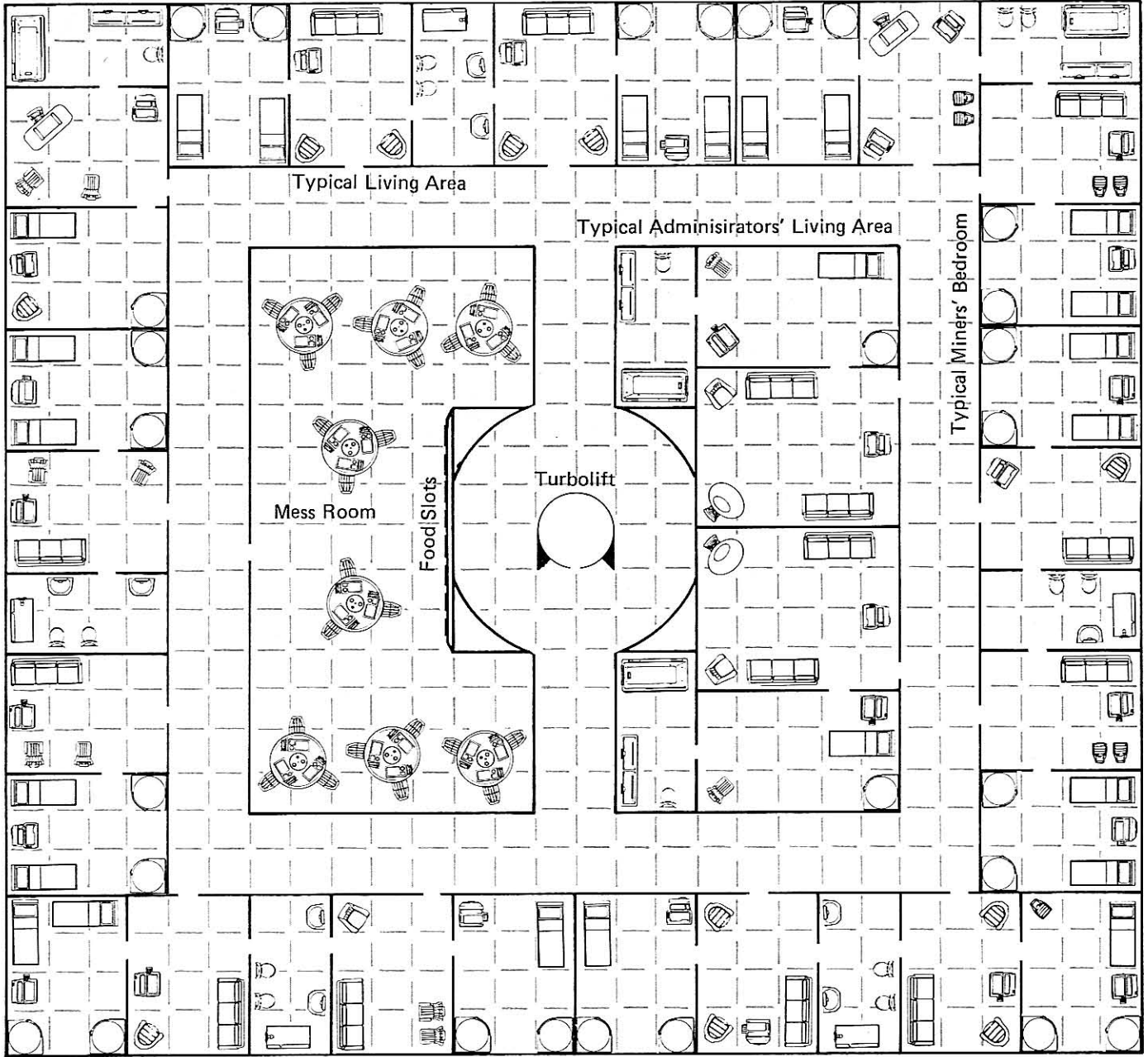

TYPICAL LIVING LEVEL Janus VI Mining Colony
Above Cavern Level

Shift Formans' Quarters



24 Miners/technicians
1 shift foreman
2 administrators

-  Wardrobe
-  Bath/jacuzzi
-  Viewscreen
-  Double Sink

ENGINEERING LEVEL (Below cavern level)

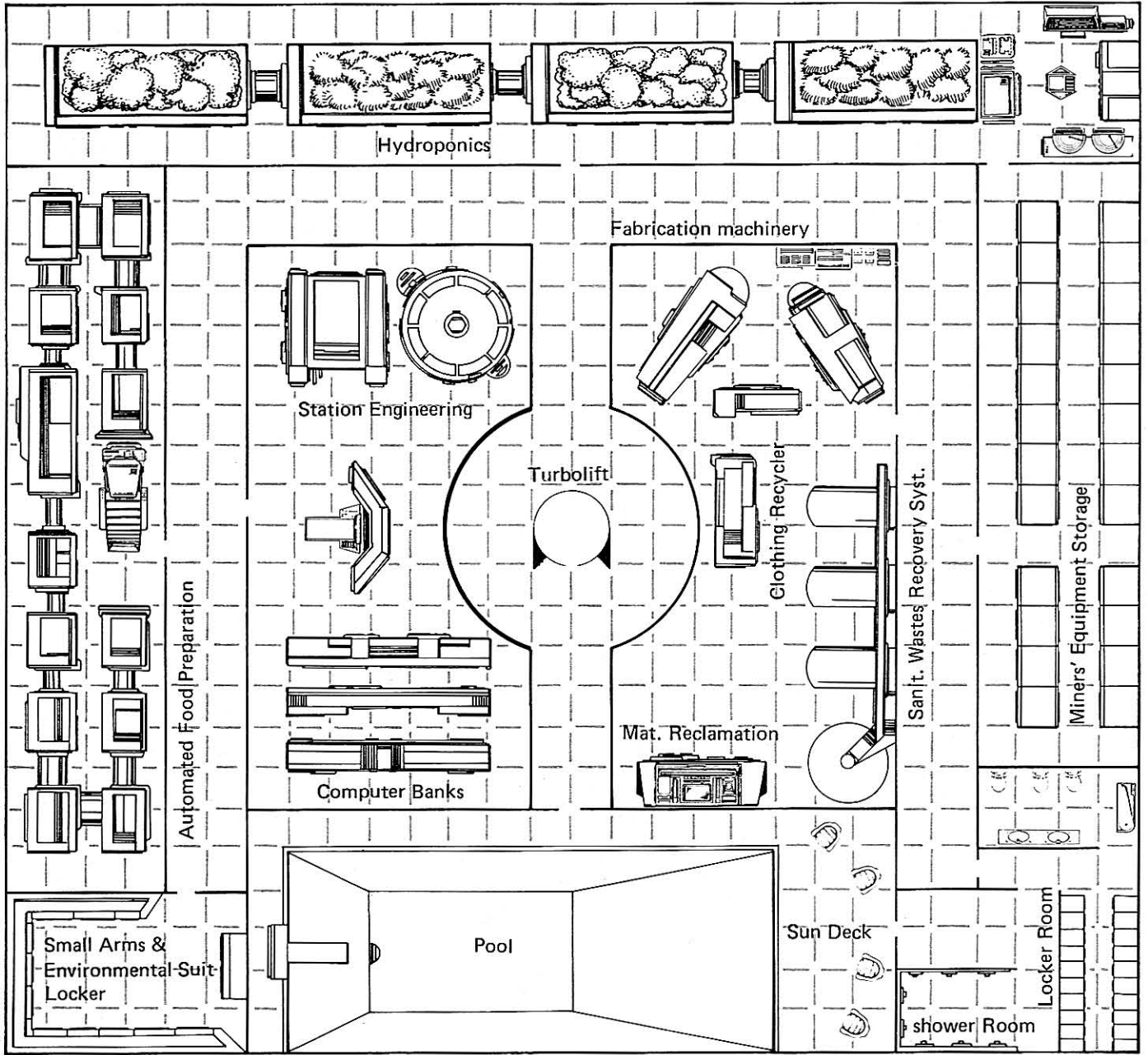

JANUS VI COMPLEX LAYOUT

15m

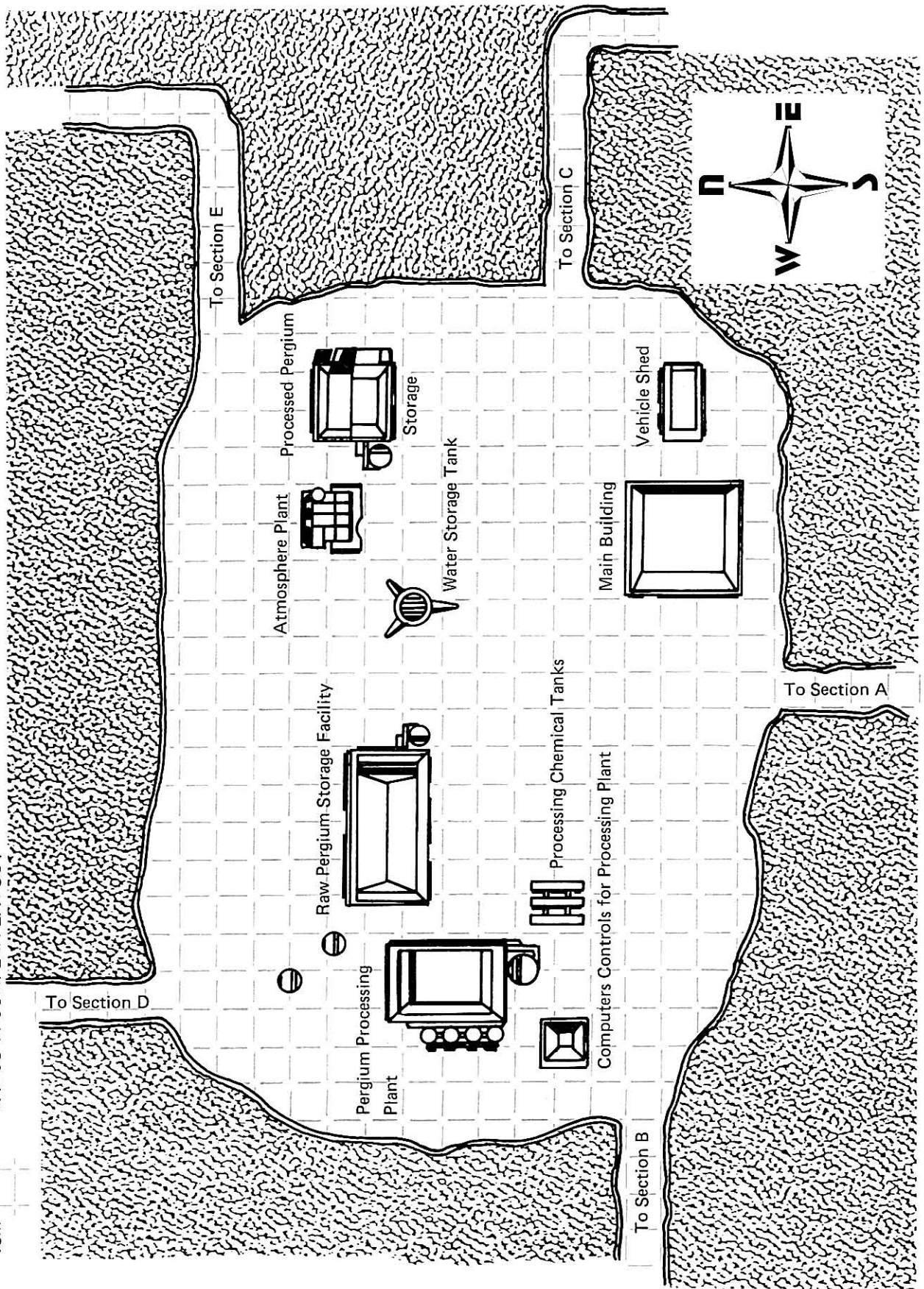

Power Plant Level

(25 Meters Below Engineering Level)

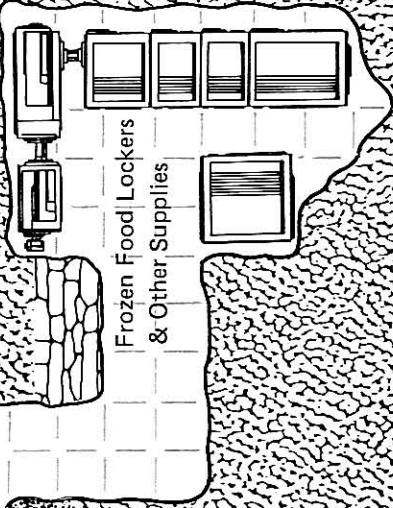
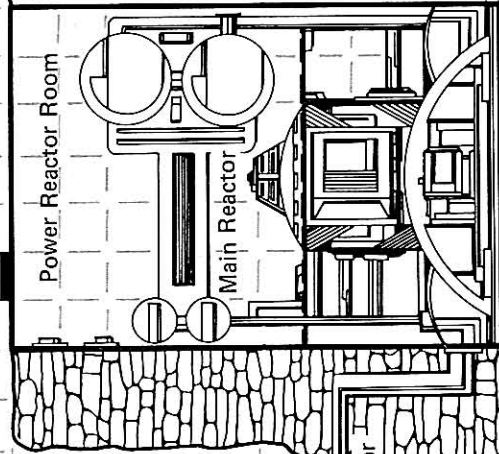
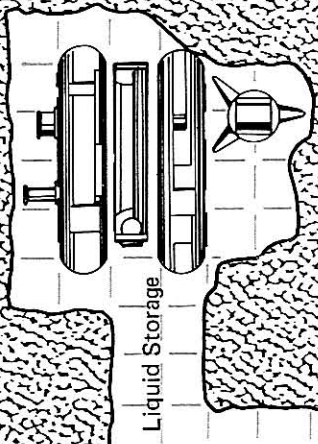
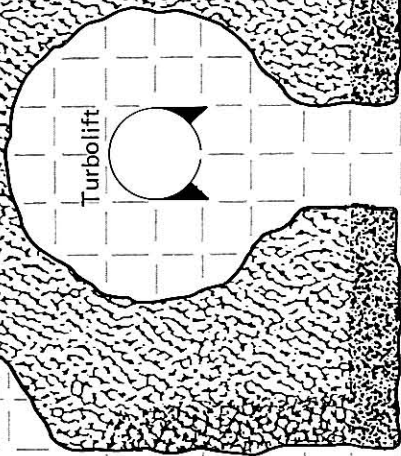
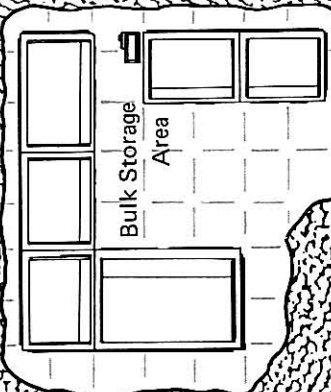

Reinforced wall Shielding

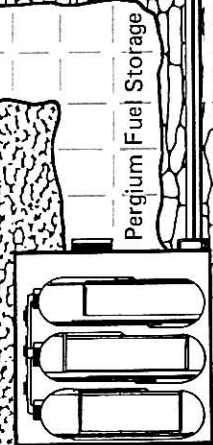

ADMINISTRATIVE LEVEL (CAVERN LEVEL)

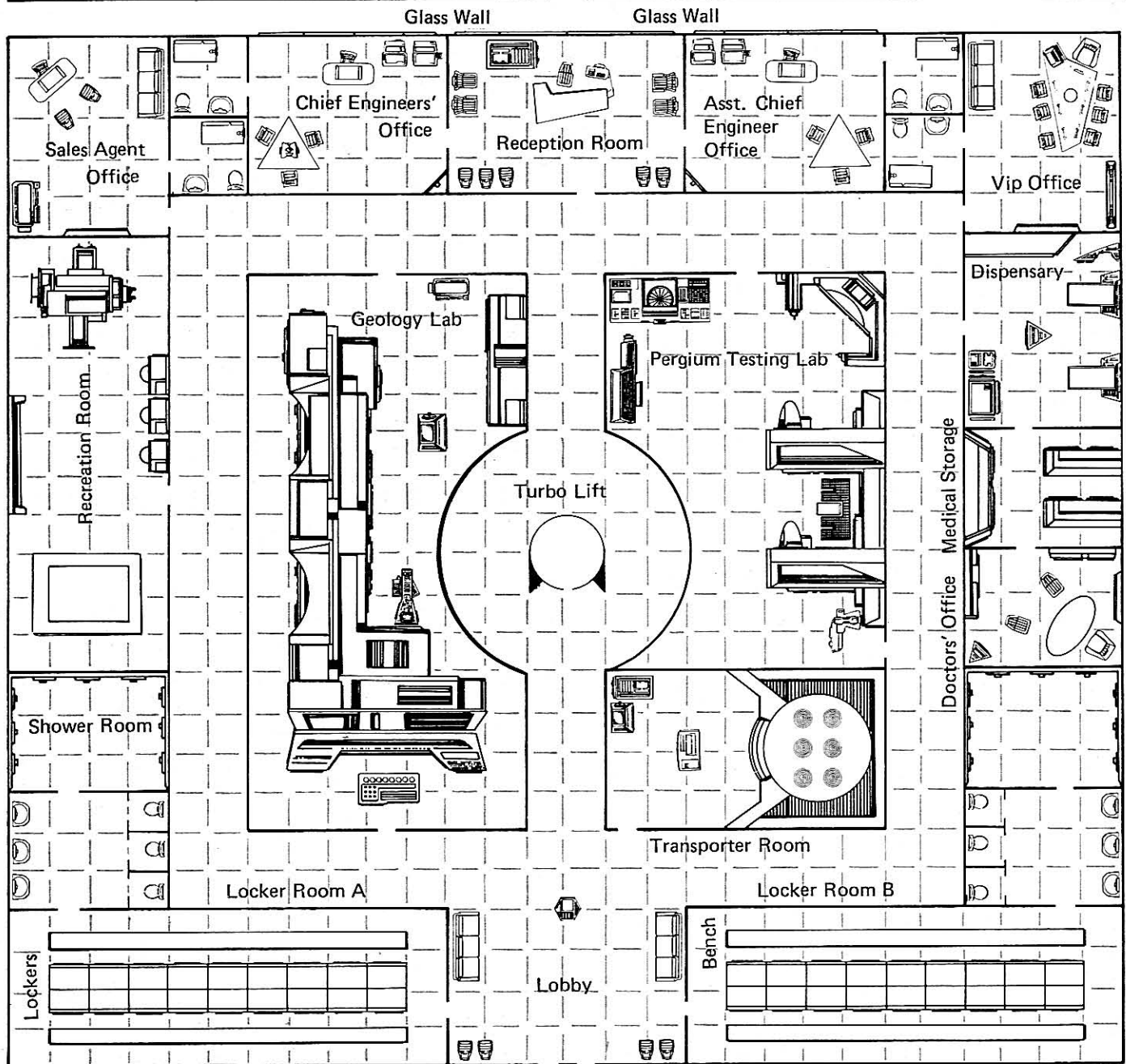

PLAYERS MAP

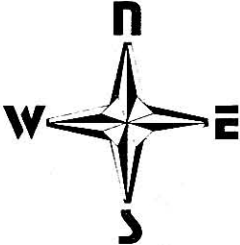
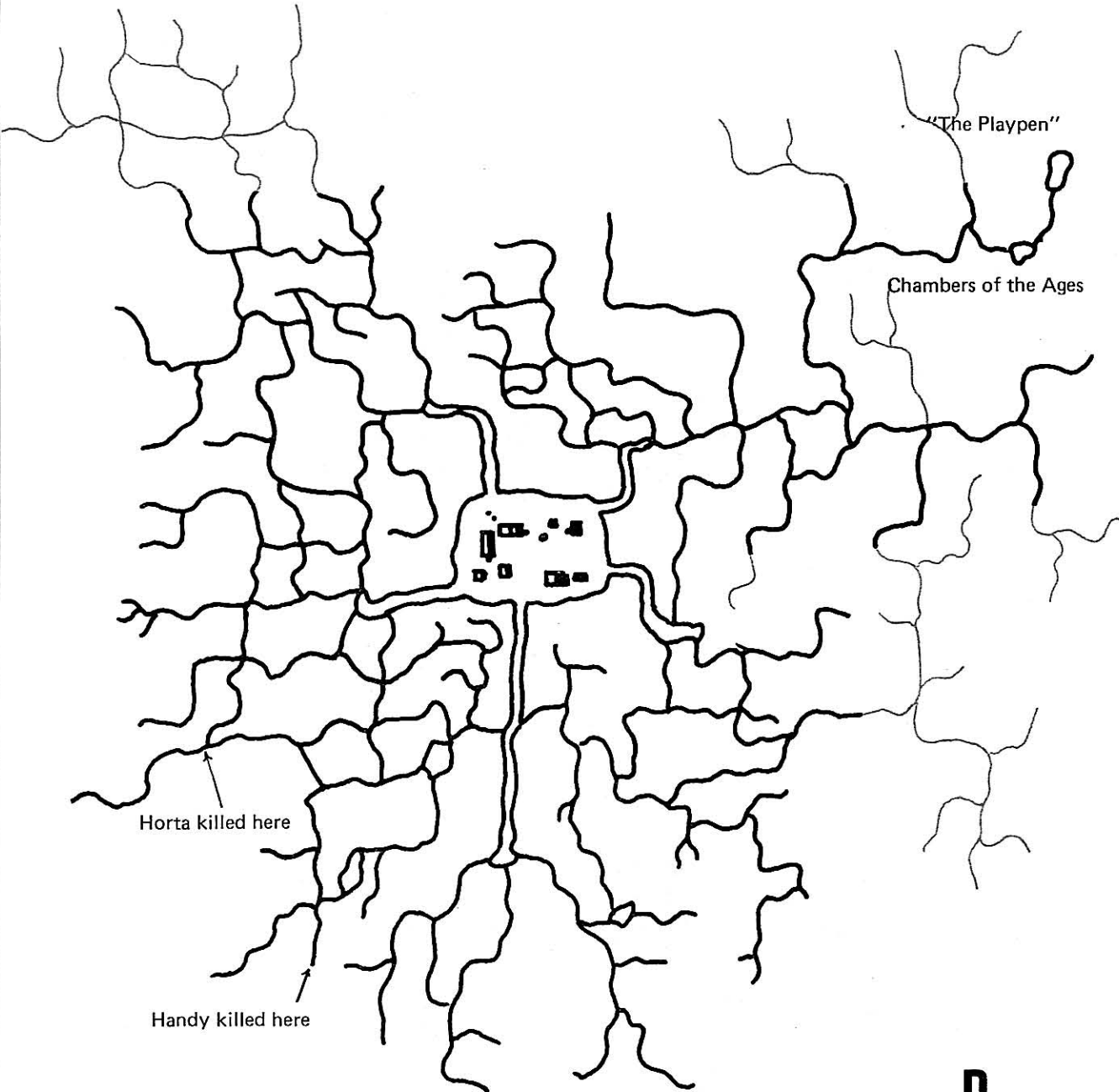

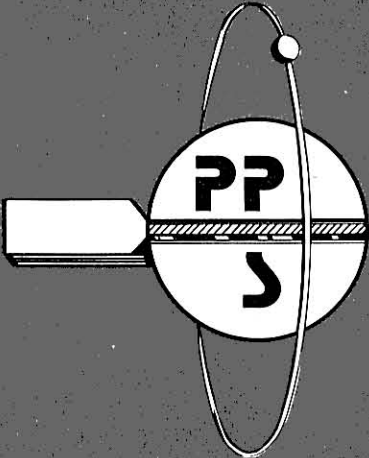

CHARACTER Conway, Randy		
PLAYER		18
RANK	AGE 24	17
RACE Human	SEX M	16
CURRENT ASSIGNMENT		15
Miner (Industrial Spy)		14
SPECIALIZATION AREA		13
Marksmanship (modern) 62		12
To Hit Modern 64		11
Personal Combat (unarmed) 52		10
To Hit H-T-H 59		9
		8
		7
		6
		5
		4
		3
		2
		1

STR 70	END 69	INT 71	DEX 66	CHA 78	LUC 51	PSI 02
---------------	---------------	---------------	---------------	---------------	---------------	---------------

Administration 14	Mechanical Eng. 31	Starship Sensors
Atmosphere Craft Pilot.	Medicine	Starship Services
Astron./Astroph.	Negot./Diplomacy 23	Streetwise 81
Botany	Personal Wpn. Tech	Trans. Op. Proc. 33
Carousing. 39	Prs. Comb. (Ar.)	Trans. Systems Tech
Commun. Sys. Tech.	Physical Chem. 28	Vocal Music
Comp. Arch.	Physics	Trivia
Computer Operation 66	Planetary Ecology	Water Vehicle Op.
Computer Tech.	Planetary Survival 31	Warp Drive Tech.
Def. Shield Tech	Psych.	Zero-G Operations
Electronics Tech 31	Rac. Clt./His.	Zoology.
Env. Suit Operations 24	Ship's Weaponry Tech	Mining. 26
Federation History	Shuttlecraft Pilot. 12	Clandestine Operations 69
Federation Law. 38	Shutt. Sys. Tech	Swimming adding 78
Gaming 24	Sm. Eq. Sys. Tech.	
Geology. 39	Small Unit Tactics	
Grav. Veh. Operation 89	St. Cmbt. Tac./Str.	
Instruction.	St. Comm. Proc.	
Inst. Music	St. Comm. Proc.	
Lang.	St. Engrg. (General)	
Leadership 22	Starship Helm Op	
Life Sup. Tech	Starship Navigation	
Marks (Arch.)	Starship Security.	

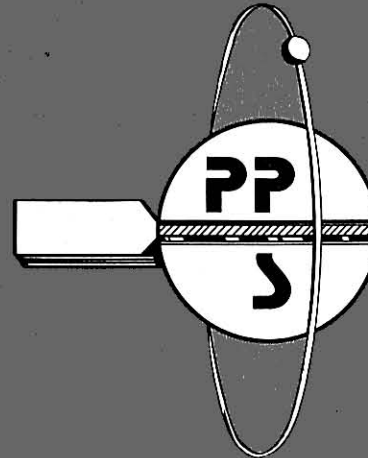

CHARACTER Solon		
PLAYER		18
RANK Lt.	AGE 38	17
RACE Vulcan	SEX F	16
CURRENT ASSIGNMENT		15
Inter-Species Liason-Pergium Production Station-Janus VI		14
SPECIALIZATION AREA		13
Psionic Interpreter		12
Marksmanship (modern) 20		11
To Hit Modern 38		10
Personal Combat (unarmed) 30		9
To Hit H-T-H 43		8
		7
		6
		5
		4
		3
		2
		1

STR 88	END 65	INT 75	DEX 56	CHA 58	LUC 32	PSI 96
---------------	---------------	---------------	---------------	---------------	---------------	---------------

Administration 30	Mechanical Eng.	Starship Sensors
Atmosphere Craft Pilot.	Medicine	Starship Services
Astron./Astroph.	Negot./Diplomacy 44	Streetwise
Botany 18	Personal Wpn. Tech	Trans. Op. Proc.
Carousing.	Prs. Comb. (Ar.)	Trans. Systems Tech
Commun. Sys. Tech.	Physical Chem.	Vocal Music
Comp. Arch.	Physics	Trivia
Computer Operation 66	Planetary Ecology	Water Vehicle Op.
Computer Tech. 21	Planetary Survival	Warp Drive Tech.
Def. Shield Tech	Psych.	Zero-G Operations
Electronics Tech 12	Rac. Clt./His.	Zoology. 42
Env. Suit Operations 14	Ship's Weaponry Tech	
Federation History 17	Shuttlecraft Pilot.	
Federation Law. 29	Shutt. Sys. Tech	
Gaming 36	Sm. Eq. Sys. Tech.	
Geology. 11	Small Unit Tactics	
Grav. Veh. Operation	St. Cmbt. Tac./Str.	
Instruction.	St. Comm. Proc.	
Inst. Music	St. Comm. Proc.	
Lang.	St. Engrg. (General)	
Leadership 18	Starship Helm Op	
Life Sup. Tech	Starship Navigation	
Marks (Arch.)	Starship Security.	

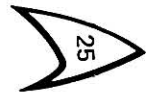

										CHARACTER	Delaney, Laura			
										PLAYER			18	
										RANK	LT.	AGE	25	17
										RACE	Human	SEX	F	16
										CURRENT ASSIGNMENT				15
										Star Fleet Legal services - Public Defender				14
										SPECIALIZATION AREA				13
										Security				12
										Marksmanship (modern) 40				11
										To Hit Modern				10
Personal Combat (unarmed) 40				9										
To Hit H-T-H				8										
				7										
				6										
				5										
				4										
				3										
				2										
				1										
STR 51	END 77	INT 81	DEX 69	CHA 73	LUC 59	PSI 28								
Administration	10	Mechanical Eng.		Starship Sensors										
Atmosphere Craft Pilot		Medicine		Starship Services										
Astron./Astroph.	10	Negot./Diplomacy	66	Streetwise	16									
Botany		Personal Wpn. Tech	10	Trans. Op. Proc.										
Carousing	23	Prs. Comb. (Ar.) Quarterstaff	10	Trans. Systems Tech										
Commun. Sys. Tech.		Physical Chem.		Vocal Music										
Comp. Arch.		Physics		Trivia - Old Earth Law	6									
Computer Operation	20	Planetary Ecology		Water Vehicle Op.										
Computer Tech.		Planetary Survival	10	Warp Drive Tech.										
Def. Shield Tech.		Psych. Human	34	Zero-G Operations.	20									
Electronics Tech.		Rac. Clt./His.		Zoology.										
Env. Suit Operations		Ship's Weaponry Tech												
Federation History	10	Shuttlecraft Pilot.	20											
Federation Law.	78	Shutt. Sys. Tech												
Gaming	42	Sm. Eq. Sys. Tech												
Geology.		Small Unit Tactics	20											
Grav. Veh. Operation	10	St. Cmbt. Tac./Str.												
Instruction.	10	St. Comm. Proc.												
Inst. Music		St. Comm. Proc.												
Lang. Vulcan	30	St. Engrg. (General)												
Leadership	10	Starship Helm Op												
Life Sup. Tech		Starship Navigation												
Marks (Arch.)		Starship Security.	30											

										CHARACTER	Levine, Laurel (M.D.)			
										PLAYER			18	
										RANK		AGE	34	17
										RACE	Human	SEX	F	16
										CURRENT ASSIGNMENT				15
										Medical Officer - Pergium Production Station - Janus VI				14
										SPECIALIZATION AREA				13
										Medicine				12
										Marksmanship (modern) 21				11
										To Hit Modern				10
Personal Combat (unarmed) 38				9										
To Hit H-T-H				8										
				7										
				6										
				5										
				4										
				3										
				2										
				1										
STR 53	END 61	INT 81	DEX 73	CHA 77	LUC 36	PSI 30								
Administration	28	Mechanical Eng.		Starship Sensors										
Atmosphere Craft Pilot		Medicine Human	81	Starship Services										
Astron./Astroph.		Negot./Diplomacy	20	Streetwise	51									
Botany		Personal Wpn. Tech		Trans. Op. Proc.										
Carousing	59	Prs. Comb. (Ar.)		Trans. Systems Tech										
Commun. Sys. Tech.		Physical Chem.	34	Vocal Music										
Comp. Arch.		Physics	15	Trivia										
Computer Operation	66	Planetary Ecology	18	Water Vehicle Op.										
Computer Tech.		Planetary Survival	9	Warp Drive Tech.										
Def. Shield Tech.		Psych. Human	29	Zero-G Operations.										
Electronics Tech.		Rac. Clt./His.		Zoology.	46									
Env. Suit Operations	32	Ship's Weaponry Tech		Mining	13									
Federation History	12	Shuttlecraft Pilot.												
Federation Law.	15	Shutt. Sys. Tech												
Gaming	21	Sm. Eq. Sys. Tech												
Geology.	18	Small Unit Tactics												
Grav. Veh. Operation	31	St. Cmbt. Tac./Str.												
Instruction.		St. Comm. Proc.												
Inst. Music		St. Comm. Proc.												
Lang.		St. Engrg. (General)												
Leadership	31	Starship Helm Op												
Life Sup. Tech	22	Starship Navigation												
Marks (Arch.)		Starship Security.												

OTHER INVESTIGATIONS

Some player characters may wish to follow other leads and learn more about the case from other sources that have NOT reported to Captain Kirk. Although it would be impractical for anyone to get in to see Jack Katz (the suspect) without Lt. Delaney and Ed Appel's permission, his side of the story can be obtained from Lt. Delaney.

Chief Engineer Vanderburg (who will act as prosecutor) will also be willing to discuss the facts of the case with any interested party from the Enterprise, as long as it is understood such discussions are not to be shared with Captain Kirk to avoid prejudicing the case.

Players may also wish to speak with Ralph Antara (Katz's closest friend) and/or Randy Conway (the work partner of Katz and the dead miner Louis Handy), based on things that happened during the tour.

All of these people would be available to any player characters who wish to seek them out. The stories each will tell are provided in this section. The Gamemaster should look the stories over and give the players such information from the stories as they ask for. Gamemasters should NOT simply read the stories in their entirety to the players. Make the players ask questions and draw out the information they want.

DELANEY/KATZ

According to Delaney, this is what Katz told her about the murders:

Jack Katz has only recently arrived at the station (two weeks before the murder of Louis Handy). He has been serving his training period before starting work with his assigned work partners Handy and Conway. All Miners work in assigned teams of three, with new men assigned to fill any gaps that occur.

Normally, new men are trained by their new partners in the use of equipment. Conway was willing to help, and Katz was grateful for his friendly advice. Handy, however, seemed to take an immediate dislike to Katz and was offensive and belligerent at every opportunity. He refused to help with the training, thus hampering Katz and causing him to take longer than usual to learn the equipment. Conway checked Katz out on the "sizzle bug" vehicle in what time he could spare, but he had only had a lesson or two on the tunnel runner controls.

The trouble with Handy came to a head on the night before Handy's murder. Katz and Handy argued and finally came to blows in one of the mess rooms, and had to be separated by Conway and some of the men.

Conway took Katz aside to cool off, and promised to talk with Handy (with whom he shared rooms) that night and try to get him to agree to do his share in training Katz.

Early the next morning, Katz found a message from Handy displayed on Katz's computer terminal. Apparently, Conway had talked to Handy, because Handy wanted Katz to come out to the southwest tunnels he had been working for some training. Katz wiped the screen message (leaving no trace of it, since such personal messages are not placed in long term storage by the station's computers) and went out to the site alone in a clumsily-maneuvered tunnel runner.



Upon his arrival, he found an unattended "sizzle bug" machine running at the end of the tunnel. The machine was not moving, but its phaser units were locked on and operating, focused just short of the end of the tunnel. Katz jumped up into the cockpit and turned off the machine, discovering Handy's blackened body in front of the beams.

Katz panicked, jumping back into the tunnel runner and heading back to the main complex. In the process he got lost in the still-unfamiliar tunnels and overturned his tunnel runner. By the time he righted it and found his way back to the main cavern, Handy's body had already been discovered by others and reported to Vanderberg and Appel. When Katz was found missing he was suspected, and detained when he returned to the main cavern and placed under restriction to quarters.

Several people came to see him during his confinement, including Appel, Vanderburg, Conway, Dr. Levine, and his friend Ralph Antara. At this point, Katz felt that the colony residents would be willing to believe his story. Meanwhile, a Federation defender was summoned, along with a starship for a hearing and possible trail.

Fearing he would be railroaded by circumstantial evidence (since he HAD fought with Handy publicly the night before), Katz disobeyed orders and sneaked out of the main building. He took an unattended tunnel runner and headed for the tunnel where the murder occurred, this time travelling slowly so the he would not overturn his vehicle.

When he arrived, he found the machine gone, but the scoop had been removed and was still there. He examined the scoop for a minute, then began looking around the nearby tunnels for the machine or other evidence and got lost again. He was still lost when Vanderburg and a search party found him and arrested him for the murder of the Horta.

Katz claims he was never anywhere near the Horta on the day it was killed.

VANDERBURG

According to Vanderburg, at least six miners, including Conway, Antara and Ed Appel, were present the night before Ralph Handy's murder when Handy and Katz scuffled in one of the mess areas. It was well-know that the two were at odds, though such was not unusual with Ralph Handy.

Handy, a longtime stockholder/miner, should have long ago earned enough credits to retire. The miner, however, had a well-known mainia for gambling, and he was a constant loser. Each time he would get a bit ahead, he would lose it on one of his frequent rest and recreation trips. Much of Handy's accumulated stock has been transferred to other miners to cover gambling debts, leaving Handy with the minimum amount to maintain his position at the colony.

Handy's losses made him bitter and argumentative, and he had no real close friends among the miners until Randy Conway arrived less than a year ago. Conway's easy friendliness must have pierced Handy's angry exterior, for the two became friends soon after Conway's arrival. The two men couldn't seem to keep a third partner for very long, because of Handy's short temper. Their last partner before Jack Katz lasted only three weeks, angered over Handy's insistence on working in an area long considered played out. According to Conway, he humored Handy, even though pursuing the wild goose chase cost him money, out of friendship. Conway says that Handy was hoping to make a big strike because the bonuses would help him get out of debt faster than normal work in the newer sections of the mine -- possibly another example of Handy's losing ways in gambling.

The morning after the fight in the mess room, Handy went out to the played-out tunnels in the southwest section, where he and Conway had been working. Conway left about the same time, but did not go on the job. Instead, he was scheduled to relieve the guard at the Horta "Playpen" which he did, on time. Katz checked out a tunnel runner about an hour later and went into the southwest tunnels.

When Conway returned from guard duty, he asked if anyone had seen Katz. When he was told where Katz had gone, he asked a couple of miners to go out and check on Katz and Handy while he had lunch. Conway then went into the main building and had lunch. Ralph Antara was also there having lunch and the two were discussing the Katz/Handy problem when the news came back that Handy was dead and Katz was missing.

Both Conway and Antara joined search parties, but while they were out, Katz showed up. Katz claimed he had found Handy dead, then gotten lost. Based on the fight the night before, however, Katz was placed under arrest pending an investigation of the death, and confined to quarters.

Upon investigation of the death, it was discovered that Handy had been burned extensively and fatally by the phaser heating units of a "sizzle bug" mining vehicle. The fatal injury was done at close range, when the victim was standing directly in front of the vehicle with his back to the operator. These facts were confirmed by Dr. Levine's examination of the body and the murder scene. The charred remains of a shovel often used by miners in clearing obstructions from the vehicle scoop were also found, suggesting Handy was carrying the object when he was killed.

The mining vehicle in question has virtually foolproof controls, making it almost unthinkable that the phaser units could have been accidentally activated. It would also have been impossible to activate them from a distance -- the murderer had to be sitting in the cab of the vehicle and deliberately activate them. The body, even once it had

fallen, would have been clearly visible from the cab, eliminating the possibility that the operator did not know Handy was in front of the beams.

Given Katz's presence in the area at the time of the murder, his motive for killing Handy, and his inability to prove his alleged reasons for not immediately reporting finding the body, Katz was ordered held for trial and a Federation legal representative was sent for, along with a starship bearing an officer of sufficient rank and position to try the case locally. Katz was offered and turned down the right to transport back to a major starport for civilian jury trial, as he felt he would get a fairer shake here, among people who knew him at least slightly.

Soon after the message was sent by subspace radio, Jack Katz sneaked out of the main building. A few hours later, search parties sent to look for him found the charred remains of the adult Horta, and a "sizzle bug" vehicle with the scoop removed. Not long after, the same party found Jack Katz in the tunnels. The scoop from the machine that killed both Handy and the Horta was found at the site of the first murder. Most miners wear gloves, eliminating any likelihood of fingerprints on the scoop, but Katz's gloves, which he was wearing when arrested the second time, were found to have particles of metal on them that could have become embedded when he removed the screws holding the scoop onto the machine.

After deliberation and investigation, the Colony Government intends to bring charges of second degree murder (in the death of Louis Handy) and first degree murder (in the death of the Horta). The Government alleges that Katz went to the southwest tunnels in search of Handy on the morning of he first murder to get Handy to agree to fulfill his obligations to help train Katz. When Handy refused, an argument ensued. Katz, angered to the point of fury, turned the deadly beams of the mining machine onto Handy when the victim moved in front of the machine.

Katz perhaps had a vague idea that the murder could be made to look like an accidnet, but that was spoiled by the presence of a witness to the slaying! The presence of recent Horta tunnels in the area of the murder leads the prosecution to believe that he adult Horta herself may have been present and witnessed the death of Handy. The Horta, though a highly intelligent being, might very well have been confused or even repelled by the sight of one intelligent being deliberately destroying another and fled. The Horta was thereafter observed to deviate sharply from it's usual routine of aiding miners and exercising the young Hortas. It wandered aimlessly, mostly in the southwest area where the murder occurred. Obviously, it was greatly disturbed by what it had seen, but it may have been unable to come up with a way to communicate what it had seen.

Panicked by the realization of what he had done and the Horta's presence, Katz left the scene. Unfamiliar with the operation of his vehicle at higher speeds, Katz overturned it. Perhaps it was while he was righting it that he decided to claim he had found Handy already dead, and had become lost on the way back. After all, the Horta, though intelligent, could not speak and name the killer, nor did he have any real reason to believe that such an alien being would particularly care about the murder.

Katz was a new miner and unfamiliar with the Horta. He may have even thought of it as unintelligent, the way

the miners who originally encountered it had done. At any rate, Katz became convinced that it was no threat to him.

This changed while Katz was under confinement to quarters. Katz had several visitors during this time, and at least one of them no doubt mentioned Lt. Solon's intention of mind-melding with the Horta. Fearful that his crime would be discovered at that time, Katz set out to slay the only witness to the crime. He slipped out of the main building, took a tunnel runner back to the scene of the first crime and removed the scoop from the sizzle bug vehicle. He had been trained by Conway on that vehicle, and knew that removing the scoop would give the phaser heat beams more clearance and greater range.

He backed the vehicle around to a main intersection and waited for the confused Horta to come through it. He then turned the beams on the Horta and the concentrated fire, designed to cut through rock, burned into the Horta's silicon structure and it was killed.

Katz no doubt intended to return to his room before he was missed, but his inexperience with the tunnel runner cost him too much time, and he was discovered before he could return.

That, in a nutshell, is the prosecution's case.

RALPH ANTARA: Ralph Antara, Jack Katz's closest friend at the Janus VI station, will be all too willing to talk to anyone who is sympathetic to Katz. In fact, if none of the players look him up for further discussion (after the initial meeting on the tour), the gamemaster should have Antara look THEM up and ask them to see to it that Katz gets a "fair shake".

Antara was in college with Katz, a year ahead of him in the same geology studies program. At one point, Katz loaned money to Antara so Antara could finish school after his family suffered some financial reverses. For this reason, Antara is extremely loyal to his friend, and will do anything he can to help him.

He will explain that he is certain Katz could not be responsible for the death of Handy, because of his long association with Katz. Katz, according to Antara, is usually very even tempered, and not given to violent acts. He insists that Katz participated in the fight with Handy the night before the murder reluctantly, only actually swinging on Handy when the older miner kicked a chair out from under Katz. (See the following notes on Randy Conway's story for HIS version of the events of the fight. Other miners present, including Appel, will claim that they aren't sure whether Handy kicked Katz's chair or Katz simply fell down while trying to jump up and hit Handy.)

Antara claims that Handy constantly baited Katz, almost as if he was TRYING to get Katz to hate him. Antara has been here a few months longer than Katz, and he says Handy has treated all his partners the same, with the exception of Conway.

When discussing Handy's bad temper, he will tell the following story:

"Just after I arrived here, I got into a poker game with Handy and some of the other old timers. The stakes got a bit high for me, but I was trying desperately to be accepted by these men, so I stayed in, risking losing more than I could afford to lose.

"Fortunately for me, I drew a couple of good hands and came out one of the winners for the evening. Beginner's luck, I suppose. Anyway, Handy ended up short and owing me about two weeks pay.

"Frankly, I wasn't really worried about the debt. I was happy enough to get out of that game with my own credits, and I swear I NEVER pushed Handy about the money. This was before Jack Katz arrived, so HE couldn't have said anything.

"But Handy seemed to take the whole thing as a personal insult. Every time he saw me he'd smart off-telling me I'd get my money when he had it to spare, and not to give him a hard time. I couldn't talk to him at all, but I mentioned it to Randy Conway, his partner. Conway said to let it pass, as Handy owed money to practically everybody on the station. According to Conway, Handy was in danger of having to sell his last bit of stock and having to leave Janus VII! And him an old timer, who should have socked a bundle away by now! But Conway said to let it ride that Handy'd get over it.

"Except Handy didn't get over it. The guy got more and more paranoid everyday, and not just to me. He must have REALLY owed everybody at the station, because he was nasty to the whole crew. We got so we couldn't stand the sight of him.

"Then, suddenly one evening, Handy was all smiles! It was like he wasn't the same guy -- laughing and talking. He paid me every dime that night, and SMILED at me! Half scared me to death! He treated us all civil for a week, but his special favorite was Conway. You'd think the guy was a long-lost brother the way Handy treated him. It was Conway this and Good Old Randy that for two weeks! I like the guy, too. He's so nice you'd just about HAVE to like him, but Handy was positively sickening about it!

"After awhile, Handy went back to being a pain in the neck again. He and got assigned a new partner. I guess old man Vanderburg figured if Handy'd gotten civilized he could be trusted around decent people again! Besides his buddy Conway, that is. It didn't work, though. Handy turned off surly again right away and the new kid got disgusted and filed a grievance. Vanderburg had to reassign him.

"It was that way on and off until Jack Katz got here. Look, there are a lot of guys here who felt like this place would be a lot better off without Handy. None of them hated him enough to kill him, though, because nobody had to work with him if they didn't want to. You file a grievance and get transferred to another team.

"And that's just what Jack intended to do! He told me right after the fight with Handy that he was going to go to Vanderburg in the morning and file for transfer. He intended to give Handy the heave-ho anyway. So why would he go out to argue with him or kill him? There's a lot of easier ways to get rid of a headache than blowing your brains out."

Antara knows better than to try and influence a starship captain acting as judge, even through his subordinates. But he would like to gain a sympathetic ear and some assurance that his friend will not be railroaded in court.

RANDY CONWAY: Conway will be glad to tell what he knows about the murders to anyone from the Enterprise

who asks, but he claims to know very little that will help. He says he doesn't really know Jack Katz as well as Ralph Antara, but he likes "the kid" and is sorry for what has happened.

According to Conway, he came from an older colony planet in this sector and grew up in a large city. His family had little money, but he managed to get along for awhile. But he hated the city and wanted out. Borrowing money from an uncle, he bought a small amount of stock and got into the Janus VI mining colony less than a year ago.

Conway will explain that he knew a lot of guys like Handy in his old neighborhood. Most of the unapproachable hotheads, according to Conway, cooled off if you treated them with respect and a lot of patience. It paid off with Handy, and Conway was able to make a friend out of a man no one else liked.

The young miner admits that "Louis never got over being a hothead", but that underneath it all was a decent, hard-working man who'd just had a lot of bad breaks. "He had no self-esteem at all, and no one really ever tried to understand him."

Handy's temper kept driving away co-workers, until the two could not keep a third man in their group at all. "It got better for awhile, but then worse when Louis got his crazy idea that there was something worth finding still in the old southwest tunnels. I guess he wanted to make a big strike to show off and impress the others. Deep down, he wanted them to admire him in some way. I knew there was nothing down there, but I stuck with him when the others were following Horta trails and getting rich. Louis was my friend, and I was the only friend he had."

"It's a shame Jack Katz couldn't get along with Louis, but Katz was a college boy and Louis was sensitive about his lack of formal education. I tried to help Jack as much as I could, but it really bugged him that Louis would not make a special effort to get Jack started.

"It came to a head the night before Louis died. He and Jack had an awful argument, with Jack insisting that Louis wasn't being fair to him, and Louis just wanting to be left alone. He got like that sometimes, and it was better just to let things lie when he did. But Jack wouldn't let up, and he finally swung on Louis. We had to drag them apart.

"The sad thing is, the incident really bothered Louis that night. I gave him a hard time about it later, and he was really sorry. I think he intended to lighten up on Jack.

"Only thing I can figure is that Jack fumed about it all evening, then went out in the morning to have it out with him. Louis might have been ready to bury the hatchet, but he was a stubborn man, and if Jack approached him in a hostile frame of mind, he'd have gone right back to being surly.

"I guess Jack just lost control. I'm sorry about Louis. He was really a fine man, despite his temper. But I suppose it's too bad about Jack, too. Sometimes, there isn't any happy ending..."

If Conway is asked about the fight, specifically about who started it, he will insist that Katz struck the first blow, though he will admit that Handy was in a bad mood that evening. About Handy's supposed gambling debts, he will claim not to know about Handy's financial affairs.

If asked, Conway will confirm his whereabouts on the morning of Handy's murder. "I was on guard duty at the Playpen, that's where we let the adult Horta leave the little ones when it's in the tunnels. We keep one man up there at all times to watch the force fields. We got the field generators from Star Fleet, as a matter of fact, they're modified from the ones used on prison doorways and things like that".

"I relieved the guard and sat out my shift. Most of the time I spent tinkering with my tunnel runner. I'm kind of a jackleg mechanic, and I've got this one special little

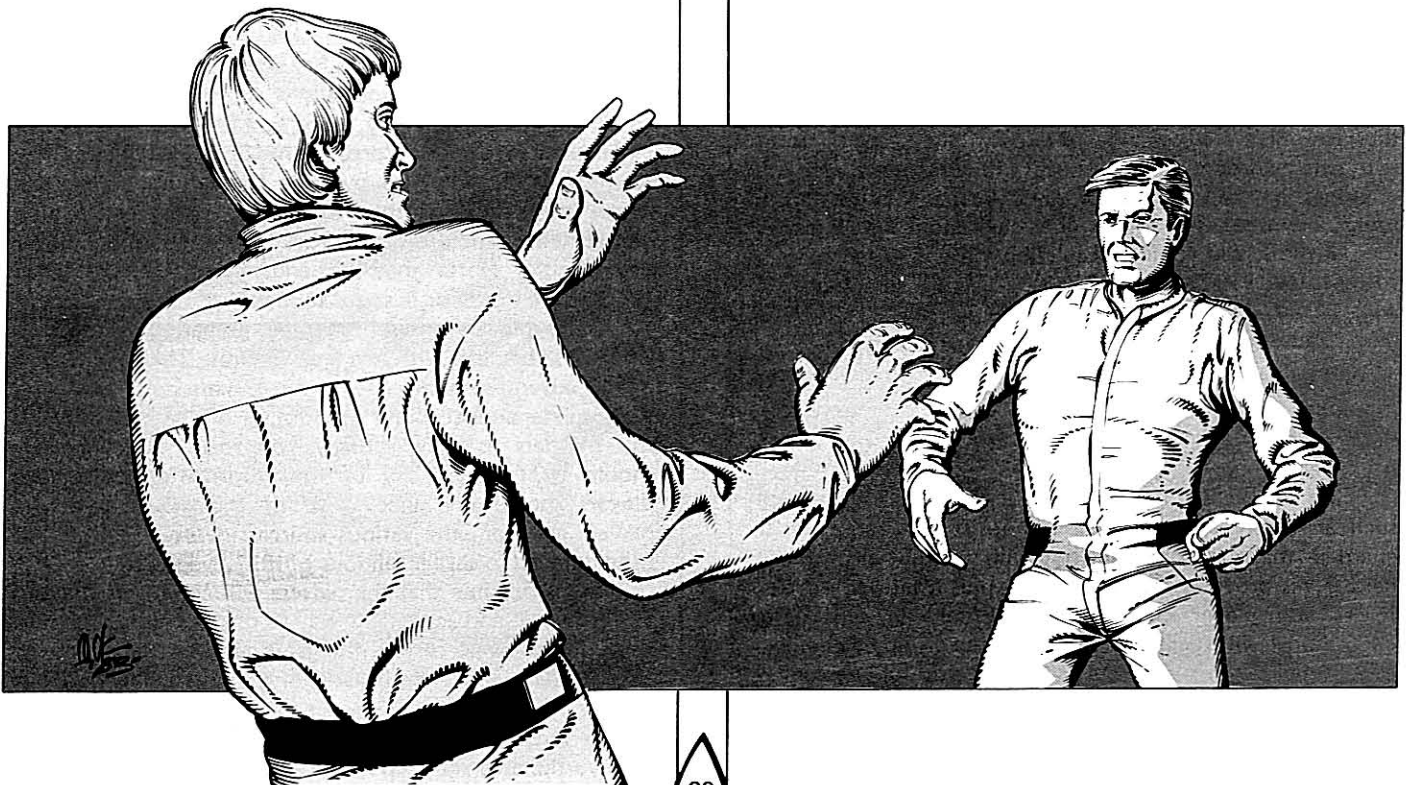

buggy I've modified a little. She really gets up and goes!
"Anyway, when I got back, Jack and Louis were still out. That was kind of unusual and I was anxious to see if they'd gotten everything straightened out. A couple of the other guys were going out, so I asked them to run up and check where we'd been working. I had to give them directions; it's not an area anybody bothers with anymore. I was still having lunch when they came back and told us all that Louis was dead."

About his whereabouts during the second murder, Conway will volunteer nothing unless specifically asked. If he is questioned specifically, he will claim to have been "looking around up in the north end, but no one else was up there yet that morning. I got back in time to be recruited for the search party, sort of a posse Vanderburg got together to find Jack. I led out one group, but we must have missed him. Vanderburg and his crew found the Horta first, then Jack."

Throughout any questioning, Conway will stick to this story with no variation, unless he is presented with a major inconsistency. The gamemaster should have him coolly explain away any inconsistencies that occur in his story in whatever manner the gamemaster can think of.

The progression of events from this point is largely dependent on the actions of the party, and the gamemaster should be prepared to be flexible. Kirk and crew may well decide to call a hearing (in place of the more formal trial) to get at the truth, especially if the Horta is discovered to be a different Horta by McCoy. (If Kirk doesn't suggest something like this, have Vanderburg or Appel do so. A formal trial cannot be held when the identity of the victim is in question, and Lt. Delaney will be very sure to stress this point in discussions of the subject with Kirk, if he attempts to proceed with a formal trial.)

With a reply to Solon's report due soon, Kirk also cannot waste much time. His first priority will be confirming that the Horta that was killed is NOT the Horta once attended by Dr. McCoy with a trowel and several bags of thermo-concrete. Available photos of the original Horta will offer absolute proof of this, if compared with the markings on the body of the dead Horta. A young Horta looks somewhat like a dark grey slug about 10-25 inches long at most, and could not possibly have matured enough to look like the dead one. (Besides all the young are accounted for in the Playpen.)

Thus the original Horta, alive or dead, must be around somewhere. Eventually, the players will consider mounting a search effort. (If, after a reasonable discussion, none of the players suggests this, let the suggestion come from Vanderburg or Appel...)

Of course, the miners will be all too glad to help with such an effort. Vanderburg will insist Katz stay under guard in the main building, but will turn out all shifts to help. This provides about 100 men, plus whatever security forces and player characters the Enterprise can spare.

Appel will suggest that each search group be composed of four tunnel runner vehicles, each driven by an experienced miner with two other people riding along. These groups of four vehicles should not split up for safety's sake. The colony only has 32 tunnel runners, which means

8 groups, each composed of four vehicles and 12 men. The extra men will stay in the main cavern to keep normal pergium processing and maintenance operations running.

When Kirk and Vanderburg start assigning areas and men to teams, Randy Conway will volunteer to lead a group into the southwest section where he and Handy had been working. Conway will explain that he has worked there more recently than anyone else, and can find his way around best in that area. He also has the fastest tunnel runner, and is generally accepted as being one of the best drivers among the miners. Vanderburg and Appel will think this is a good idea, and will accept his offer unless Kirk objects. The gamemaster should secretly make note of what player characters from the Enterprise -- if any -- are assigned to Conway's group. If Conway's offer to lead one group is rejected by Kirk, the gamemaster should make secret note of what group Conway DOES end up with, whether or not Conway is driving -- if so, he will take his own hopped-up tunnel runner -- or note if Conway is left with the group at the main cavern.

Gamemasters should remember that Conway is very well-liked by most of the miners. Even if Kirk is suspicious of Conway, unless he has evidence to back up any allegations, the miners will not take kindly to any suggestions by the Enterprise officers that Conway is not trustworthy. If the Enterprise officers make unsupported accusations, they will find the miners reacting unfavorably toward them. If the accusations are strong and totally unsupported by hard evidence, Vanderburg is within his authority to overrule Kirk in this matter. (Kirk has absolute authority only if there is a trial - otherwise he must follow local civil authority unless Federation security is threatened.)

The Vulcan Lt. Solon could be important to Kirk, if he suspects Conway. Though Solon is also an outsider, he has been here longer than Kirk and some of the men know him. Also, Vulcan's have a reputation for trustworthiness and truthfulness. Solon will examine any evidence presented to him by Enterprise officers in a logical manner and will NOT make intuitive decisions based on speculation. Still, if approached correctly (especially if approached by Spock), he may be a valuable ally, since as a representative of the Federation Diplomatic Corps, he has one piece of authority Kirk does not - he can overrule Vanderburg in matters where the safety of the Horta are concerned. Solon himself will point this out to Kirk if he or any other player suggests the Horta may be endangered by a decision Vanderburg makes or is about to make.

The players should now be preparing for search, which will be dealt with in a later section. The next section of this adventure package is for the gamemaster's eyes only, a complete and accurate accounting of the truth behind the murders as they actually happened. Gamemasters should NOT reveal any of this information unless the players specifically uncover it for themselves! All the players get from the various sources involved is what has been detailed in earlier sections of this adventure.

It is possible that the players will come across a perfectly logical and acceptable way to uncover other evidence that would reveal certain things about the true nature of the murders. Make it difficult for the players to do so, but if they have been truly clever enough to outwit the gamemaster (and outguess the designers of this scenario), they deserve the clue they have worked hard to get. Do not give

away the whole plot at once, do not give away ANY other information too lightly. Clues enough are provided in conversations with the miners and others as mentioned

earlier. In the following narrative of the truth about the murders, the significance of these clues will be pointed out so the gamemaster can see how the mystery unfolds.

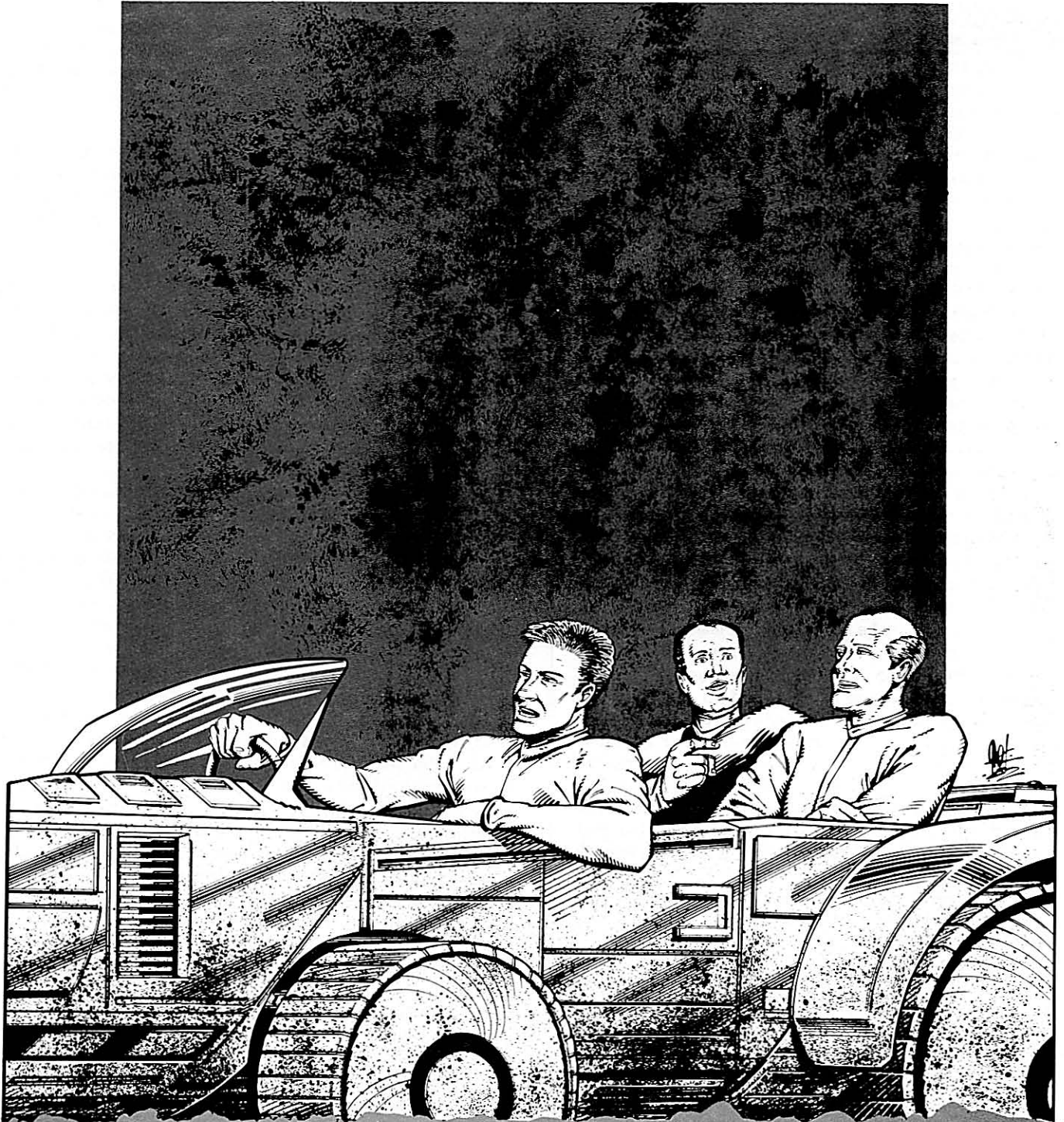

Gamemaster Information

THE MURDER OF LOUIS HANDY

Louis Handy, a long-time stockholder/miner at the Janus VI mining facility, would have long ago earned enough credits to retire, were it not for his bad luck at gambling. Each time he got a bit ahead, he'd lose most of it in one of his frequent R&R trips.

Embittered by his bad luck, Handy was hard to get along with, causing many miners to avoid working with him. Mostly, Handy worked with new miners who had yet to be the receiving end of his quick temper.

The one man Handy did get along with was Jack Conway. Only on the job less than a year, Conway was easy-going and friendly. Soon after his arrival, Handy's temper improved and the two men began working together, along with a shifting list of third partners -- many of whom still couldn't get along with Handy.

The truth of the matter would surprise and anger most of the colony. Friendly Randy Conway is actually an industrial spy in the employ of a rival mining corporation. He has drawn on his secret bank account to loan Handy large sums of money to cover gambling losses, hoping to win Handy's friendship and help in his assignment to find ways to slow up the mineral output of Janus VI.

Handy responded well, and Conway eventually hired him for various minor industrial spying jobs in the mining colony. The Horta young, being trained by the lone adult, would in a few years be old enough to learn to help with the mining operation. When that happened, there would be no hope of slowing up Janus VI's production schedule.

Handy continued to make it hard on new third men in their mining team, under instructions from Conway who felt a regular third partner would hamper their spying activities. Having just forced one new partner to transfer, Handy and Conway decided to work alone in an area long considered played out. Such an area would explain why they did not bring back much pergium, covering their clandestine activities. While working this area, the two discovered a large vein of unusual crystal.

Secret tests performed by Conway revealed that the crystal's unusual composition resisted all known corrosive agents, including the acid produced by the Horta. This property could conceivably make the crystal worth more than the pergium! The existence of such crystal structures was suspected by the colony's resident geologist, but no one suspected it could exist in quantity. Conway and Handy intended to conceal their find.

Soundings near the crystal vein produced more astonishing results, revealing the existence of tunnels and chambers on the other side of the vein, where no tunnelling had ever been done. Using mining vehicles to cut through the crystal layer, Conway and Handy discovered a previously unsuspected SECOND Horta colony beyond. The two colonies were unaware of each other's existence, since Horta cannot tunnel through the non-corrodable crystal layer. The second colony consisted of a single adult and thousands of unhatched Horta "eggs"-- the familiar silicon spheres. Unlike the original colony, these nodules were not

yet ready to hatch, being younger than the other "eggs" by quite a few years. Katz and Handy sealed the tunnel with an electronic force field device (used to keep the baby hortas of the first colony from wandering) and concealed the entrance.

When informed that they were about to get a new partner Jack Katz, a new arrival-Conway told Handy to pick a fight with the young miner, hoping Katz would be upset enough to request another team. The two argued, and finally fought publicly, but Katz did not request a new assignmet.

Fearing Katz would discover the secret if he joined them, Conway convinced Handy they would have to arrange an "accident" and kill Katz. Handy, sensing he had Conway over a barrel, demanded more money if he were to be forced to participate in murder. Conway agreed, but double-crossed Handy by setting HIM up for death instead. Handy's fight with Katz in the mess room (suggested to Handy by Conway himself) played right into Conway's hands.

The next day, Conway went out to his guard post and Handy went out to the site to set up an "accident" for Katz. Unbeknownst to Handy, Conway had left a computer message for Katz, signed with Handy's name, asking Katz to come out to the southwest tunnel work area. Once Conway took his guard post and the guard he relieved had left, Conway rode his high-speed tunnel runner out to where Handy was working, supposedly to help Handy set up a fatal accident for Katz. Instead, Conway baited Handy in front of the phaser heat units on the "sizzle bug" vehicle by asking his partner to retrieve a shovel Conway left lying there. Conway then killed Handy and left before Katz-who was not an experienced driver, and would have to drive slowly-could arrive. As he prepared to leave, he noticed the adult Horta, swiftly burrowing away, and realized that it had seen him kill Handy. Even so, he continued with his plan and was back to his guard post long before Katz even discovered the body.

The plan might have worked. Katz was placed under arrest by mine officials and a Federation judge was summoned for a trial. Conway counted on his well-known friendship with Handy and the essentially rough frontier justice of the colony to keep suspicion off him.

He had not, however, counted on two obstacles to his plan. The original mother Horta, exploring tunnels, witnessed the death of Louis Handy. Conway, worried that the intelligent Horta might give him away, baited the Horta into the tunnels beyond the crystal layer (by displaying silicon eggs found in the second chamber) and released the other Horta instead. He then used the force field unit to close the tunnel, and concealed the entrance to the digging area with a large rock. Conway counted on no one being able to tell the difference between the two Hortas. (Indeed, Conway himself could not, and had to be very careful to release the right Horta...)

Unfortunately, a recent arrival Lt. Solon (a Vulcan on detached duty from Star Fleet intended to establish

mental contact with the Horta in a cultural contact experiment conducted by Star Fleet. Conway, fearing that if the "new" Horta's erratic behavior did not give him away that Solon's "mind link" would reveal it was NOT the original, and thus was forced to kill the second Horta. It was just coincidence that Katz was out of custody at the same time, but Conway took full advantage of the situation when it presented itself.

Conway fully expects to get away with it, since Katz's escape from custody the first time makes him such a likely suspect. The arrival of the Enterprise crew, and the interest that they are taking in the case, has him worried, though. Conway is an experienced industrial spy and a completely conscienceless individual. He will stop at nothing, if he is threatened with exposure. Unfortunately for him, if he is discovered he has nowhere to run, so he will do anything he can to divert suspicion from himself, while keeping his friendly, easy-going image among the miners.

The only way to accuse Conway of the crime and make it stick is to find the concealed tunnel and free the Horta. (The tunnel is described in a later section of the adventure.) Conway knows this, so if he thinks there is danger of the hidden tunnel being discovered, he will try to divert attention from that area. If all else fails, he will try and slip away from the group and eliminate the only "witness for the defense" who can clear Katz and implicate him—the original adult Horta.

SEARCHING THE TUNNELS

The players will have to assign the available personnel to search groups. The station's geologist and Ed Appel will stay in the main cavern with whatever miners are left to continue maintenance and pergium processing operations. Dr. Levine will also stay behind, keeping one tunnel runner and a driver to respond quickly if any of the teams reports an injury. All of the other tunnel runners (32 of them, including Randy Conway's souped-up model) are available for the search effort.

Vanderburg will automatically head up one search team, and Conway has volunteered to lead another, in the southwest section he is so familiar with. The compositions of these teams, and the leaders of them, are up to the players to choose, but all of the drivers must be miners, or at least player characters with Ground Vehicle Operation skill levels of at least 40. A character may Lead the party—that is, direct the search, without actually DRIVING a vehicle. (Player characters who choose to drive get a 10 point penalty to that skill level when determining the highest operational speed they can safely obtain with a tunnel runner, because this particular TYPE of vehicle is unfamiliar. If a player has earlier had opportunity to learn how to use one from a miner, and has stated he/she was doing so, the penalty is not applied. See the equipment section of this adventure for specifications of the tunnel runner vehicle and data on operational speeds and saving rolls.)

Vanderburg will choose the search areas for each team (the gamemaster will do this), as noted on the gamemaster map of the tunnel network. Show the players on their player map which areas they will search. Vanderburg will automatically assign a party led by Conway to area 6, unless someone objects..

The miners themselves do not use communication

decides, since most civilian-made items of this type are defeated by the rock walls of the tunnels. Federation issue communicators, however, are more powerful and will penetrate the rock. Thus, any group equipped with one can keep contact with the main cavern and all other groups. The rock wall WILL prevent tricorders from functioning beyond very close range.

When assignments are made, take each area IN NUMERICAL ORDER and trace out a search route. The gamemaster will trace the route if the leader of that group is a non-player character. If the leader is a player, that player picks the search route on the player map, and shows where he is going. When the gamemaster is doing the searching.

If Conway is leading the group in area 6, the gamemaster should note carefully the tunnel intersection shown on the player map, but the player map where the Horta was killed. (This is shown on the gamemaster map AND on the player map, but the player map does NOT show the secret tunnel extension, only a short dead-end spur that actually leads to it. When Conway's team gets to that intersection, he will pass by the spur, never actually leading the team down it. If someone asks about it, he will say "It's a dead end—there's nothing down there." Only if the players insist will he go down the spur to the end on the players map. If no player characters are along on his team, they do not get the opportunity to protest.

If Conway's team is forced to go down the spur to the end (where it connects on the gamemaster's map with the concealed corridor, the corridor will come to an end where it does on the player's map. At this point, the gamemaster should make a secret INT roll for each player character in that group. If the roll is successful, the players should be told that his character has noticed something funny about a large rock at the end of the tunnel. If the players present decide to investigate, they will find that the rock conceals a small tunnel, just big enough to accommodate a tunnel runner.

The rock is very large, but it can be moved by attaching a length of chain (carried in all vehicles) around it and pulling it away with one of the sturdy tunnel runner vehicles. (Indeed, this is just how Conway put it here in the first place...) During this operation, Conway will attempt to sneak back to his souped-up runner and escape. If no one in the group has been specifically designated to watch him, he will succeed, the players noticing only when he guns his vehicle and pulls away. There is no hope of catching him, as his vehicle is faster, and he is a better driver than the other miners.

If Conway cannot sneak away, he will be along when the team finds the hidden tunnel. It should then be sketched in by the gamemaster down to the place where it penetrates the crystal vein. Here the search group will find a force field unit closing off the tunnel. The unit is one from station stores, just like ones used to keep the Horta young inside "the Playpen". It can easily be turned off from the outside so the group can proceed. It is at this point in the tunnel when they will also notice the crystal-line structure. (Anyone who has seen the station geologist's work on such crystals gets a standard INT saving roll to remember that and recognize this crystal as being similar.)

Conway, if he did not manage to slip away earlier, will still deny he knows anything about any of this, pointing out that any miner could have come down here and dug

this tunnel or stolen a force field unit. He will remain cool and unruffled, despite any suspicions or questioning.

If the players continue down the tunnel, they will soon reach the second chamber illustrated on the game-master map. This should then be drawn in on the player's map by the gamemaster. This chamber is full of the familiar silicon nodules now known to be Horta eggs. Horta tunnels lead off in all directions.

Conway will continue to deny everything, but a few moments after the players arrive here, a large shape will approach down one of the Horta tunnels. It is the original adult Horta, who has been searching for a way through the crystalline vein and was attracted back to this chamber by the vibrations of the approaching vehicles. (The eggs here are, of course, not HERS, but rather those of the other Horta, now dead. The original Horta has respected them and kept an eye on them, however.)

When the Horta sees Conway, she will recognize him and will be exceedingly angry. She will move threateningly toward him which will finally break his self-control. Conway will beg the players and other miners present to protect him from "that ugly thing", and will offer to confess everything if they will just not let the Horta near him. If the players and miners then take Conway into custody, the Horta will not harm him. If, on the other hand, the players do not act to protect Conway immediately, he will draw a Phaser I he had concealed (set for disintegrate) and shoot the Horta. The shot will have no effect -- Conway has momentarily forgotten that the Horta's silicon structure is resistant to phaser fire unless the weapon is reset to be more effective on silicon. The Horta will then attack Conway with her acid as soon as she is within range. If she hits him, he may very well be killed, before the players can calm her down.

If Conway escapes prior to this, he will NOT head back to the main cavern. Instead, he will circle around through the network of tunnels to the northeast section and "the Playpen". If the players have not specifically given the single guard there a communicator, they will be unable to warn him about Conway unless the players send the area 3 search group to check with him (assuming that group DOES have a communicator).

Upon reaching "the Playpen," Conway will catch the guard by surprise and kill him with his concealed phaser I. He will then turn off the force fields and release the baby Hortas. Unfortunately for Conway, some of them will blunder his way. These hortas have not grown a rocky outer integument yet, and are hence more vulnerable to phaser fire. He may hurt one or two, but he will fall victim to his own plot and be killed by the acid of the baby Hortas.

The released baby Hortas are a terrible threat to the colony. The shutting off of the force fields in "the Playpen" will sound alarms in the main building and warn Appel and the others who stayed behind of the danger. Lt. Solon and Dr. Levine will point out that if the baby Hortas are not stopped in some manner, they will no doubt eventually tunnel into something important like the processing plant or the reactor room and destroy vital life support equipment, injure or kill miners, or perhaps even blow up the whole station!

Of course, the only way to stop the baby Hortas is for the search team to free the mother Horta. Once she is

free, either Solon or Spock can mind meld with her to communicate the danger. Once this is done, the Horta will swiftly tunnel to catch up with her children, attracting them to her by means of pheromone scent attractants -- a Horta means of communication. She will soon round them all up and return them to "the Playpen" safely.

If for some reason Conway is sent with a different group or left behind in the main cavern, he will be afraid the cavern will be discovered. He will slip away as soon as possible and make his way to the secret tunnels, concealing himself nearby. If the search group goes down the dead end spur and finds the concealed tunnel, Conway will wait until they go into the concealed part, then use his phaser to cut away supporting structures and start a cave-in, hoping to trap the miners beyond. Conway will miscalculate in his haste, and justice will be served when the collapsing rock falls more widely and swiftly than he wanted, striking and killing him in the process.

If this happens, the Players will have to find a way out. If the trapped group has a communicator, they can call for help and the miners outside can bring a sizzle bug to cut them out. (The noise of the tunnel collapse will carry throughout the mine, so even if no communicator is available, they will be found and rescued eventually.) If they continue on down the tunnel and free the Horta, she can cut them an escape tunnel, since the cave-in is set in normal rock area, not among the acid-resistant crystals.

AFTERMATH

Whether Conway is captured or killed, a search of his belongings will find his diary, containing coded entries which reveal him to be an industrial spy. (The big corporation he works for may later lose its charter, though they did not condone, nor were even aware of, the murders committed by their agent.)

The crystalline deposits will indeed turn out to be a more valuable commodity for mining than the pergium. The remaining miners will be ten times richer because of the new find.

Of course, Conway's confession (or entries in his coded diary - which can be decoded by Enterprise computers) will completely clear Jack Katz. Also, since he never got around to filing his transfer request from Conway and Handy's team, he will be officially credited with half of the bonus money from the crystal strike, even though he knew nothing about it. The other half will go to Handy's family. (Even if Conway survived he would get nothing, as Federation law prohibits a person from profiting in any way from an act of homicide.)

As a final happy note, Lt. Solon will mind meld with the Horta and report that she is willing to look after the thousands of eggs left behind by the slain Horta. Once her own family is grown, there will be more eggs that will mature for another colony. Perhaps there are even more isolated Horta colonies within the planet. Lt. Solon reports he will recommend that the Federation finance a permanent research station on Janus VI to search for them.

Solon further reports that the Horta wishes to thank her friends from the Enterprise for reuniting her with her children. She hopes that someday, when they are grown to adulthood, that some might be allowed to journey into space to find other planets to tunnel and explore, along side their Vulcan and human friends.

Vehicle Specifications

There are two unusual vehicles used by the miners of Janus VI. These vehicles are completely described in this section. Any of this information may be obtained by the players by consulting the computer terminals at the station, or by asking any miner.

MODEL L "TUNNEL RUNNER" MINING-VEHICLE

The tunnel runner is a three-man vehicle used by the miners to get back and forth through the tunnels. It is fast and maneuverable (top speed 40 km/hr), but somewhat tricky to drive over rough terrain and through narrow tunnels, especially for those with little or no experience.

Miners who are very skilled with the machine can get it up closer to top speed in the tunnels safely, while people with little experience - through they CAN operate the basically simple controls-must hold down the speed or risk accident.

To determine the highest safe operating speed for a

tunnel runner, divide the Ground Vehicle Operation skill level of the driver by 100, and multiply the resulting number by 40 km/hr (the absolute top speed of the machine). This gives the highest safe speed in km/hr.

If a driver exceeds the safe speed of operation, the driver must attempt a saving roll on LUC saving roll (at the same penalty above for excess speed) to avoid suffering 2D10 of injury. Also, it will take 2D10 minutes to right the vehicle and get it operational again. There is 2 chances in 20 (roll a 20-sided die, with occurrence on a roll of 1) that the vehicle is too damaged to get rolling again without extensive repair work.

The tunnel runner has an open cargo bay at the rear which will hold up to 1/8 metric ton of processed ore for transport from tunnel end to central storage area.

Randy Conway's favorite tunnel runner, which he uses every day, has been customized to be faster and more maneuverable than the average. It has a top speed of 50 km/hr, and all calculations for operational safe speed should be based on this figure.

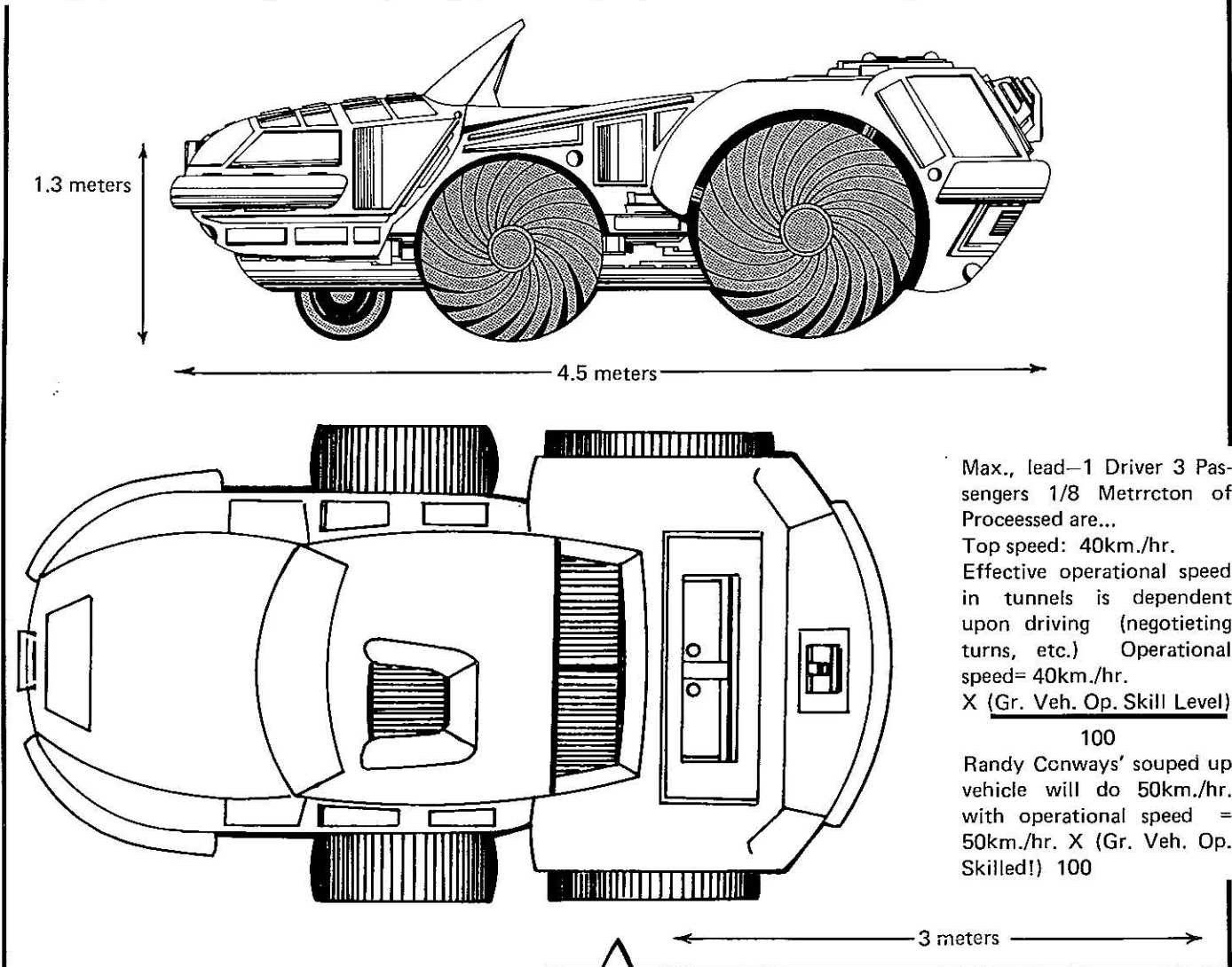

Max., load—1 Driver 3 Passengers 1/8 Metric ton of Processed ore...

Top speed: 40km./hr.

Effective operational speed in tunnels is dependent upon driving (negotiating turns, etc.) Operational speed= 40km./hr.

X (Gr. Veh. Op. Skill Level)

100

Randy Conways' souped up vehicle will do 50km./hr. with operational speed = 50km./hr. X (Gr. Veh. Op. Skilled!) 100

MODEL S3 "SIZZLE BUG" MINING-VEHICLE

The sizzle bug is a slow-moving tracked vehicle with powerful phaser heat units used for tunnelling and melting rock to have pergium processed out of it. The molten rock flows into a front mounted heatproof scoop and into the sizzle bug's sophisticated internal processing machinery. This machinery separates the pergium from the molten rock and preprocesses it, dumping it into a 1/8 metric ton capacity hopper in back. The molten rock is then flowed out through a heat proof exit tube off to the side and behind the vehicle.

The Phaser heat units are four times as powerful as a phaser rifle on heat setting, but are focused for short range. With the scoop attached, the beams only extend just past the scoop in front (about 1.5 meters). With the scoop

removed for fast tunneling operations, the beams will focus farther, about 6 meters out.

The tracked sizzle bug is heavy and slow, with a top speed of only about 10 km/hr. Thus, it would be impractical to run them out every shift from the main cavern to the remote tunnels. They are therefore left in the work area at shift's end, with miners travelling back and forth by tunnel runner. Each sizzle bug has only one seat, for the operator. Special safety interlocks on the phaser heat unit controls require two hands to operate them, thus making it virtually impossible to activate them by accident. The transparent "windscreen" of the vehicle is proof against any low power phaser energy and heat to protect the driver from reflected energy and the heat of melting rock.

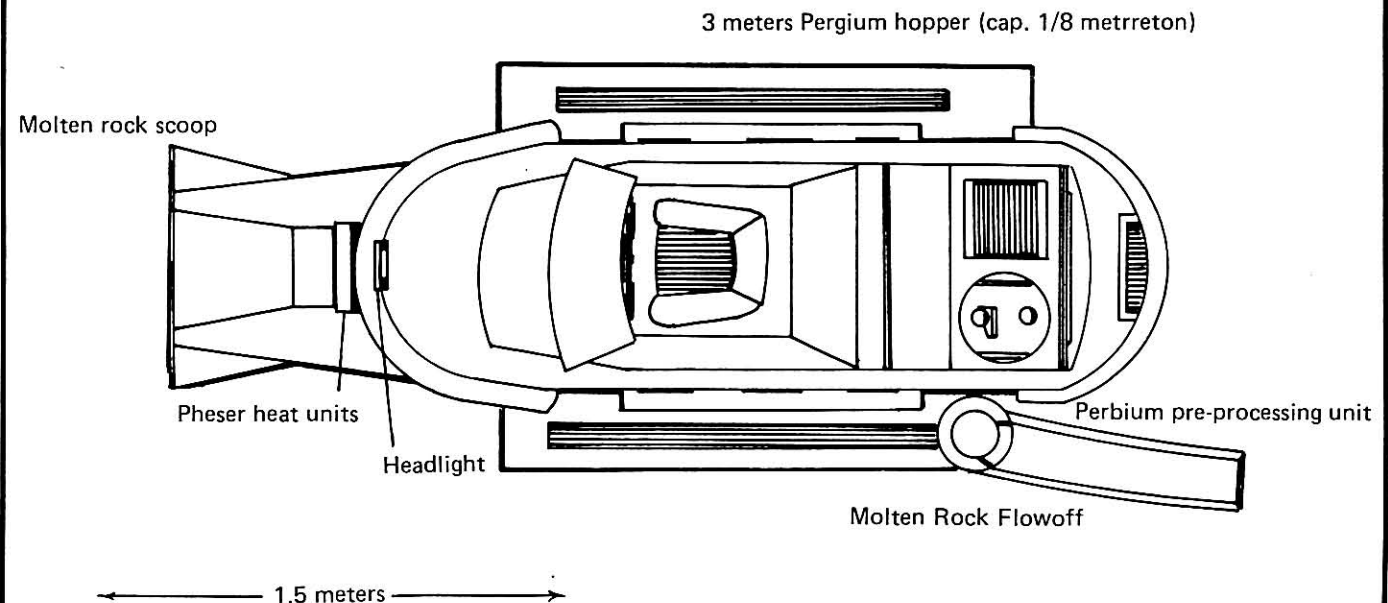
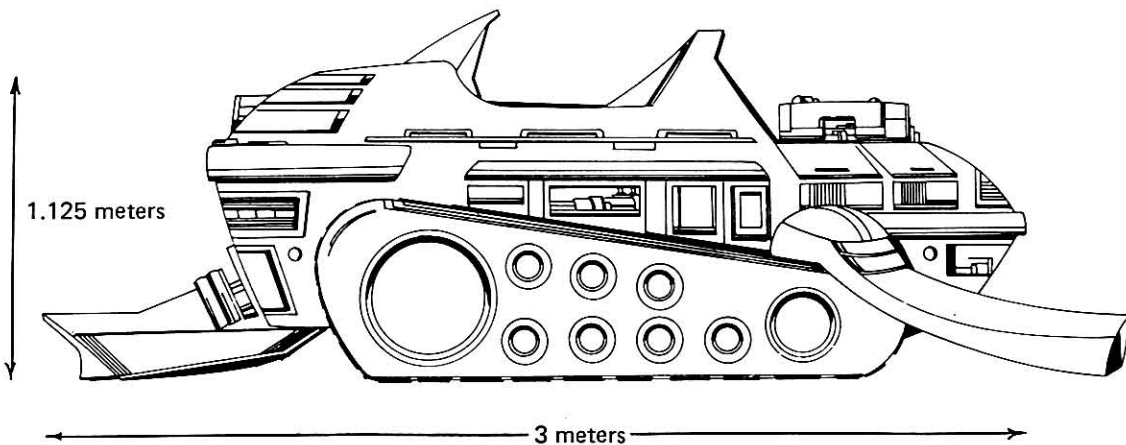

Character Statistics

The game statistics of important non-player characters are provided in this section. Some of the characters have been given a full range of skills, while others have been provided with only a list of those skills likely to be most significant.

There are three new skill categories represented among the non-player characters, and the descriptions of these skill areas are provided below.

MINING: Knowledge of techniques used in mine operation and tunnelling operations in STAR TREK's time. A skill level of at least 10 implies a general familiarity with such techniques, to the point that a person could converse intelligently on the subject. Skill levels of above 20 imply a level of expertise that would probably only come from experience as a miner/mining engineer.

CLANDESTINE OPERATIONS: This skill area encompasses the techniques used in conducting undercover police work, espionage, or other activity where information must be gained to tasks must be performed under concealment of some type.

A skill level of at least 10 implies a general familiarity with such techniques to the point of being able to converse intelligently on the subject. Skill levels above 20 imply a level of expertise that would probably come only from experience in the field.

Persons with this skill (at a level over 20) would be able to maintain a "cover" identity without suspicion under normal conditions, and be able to successfully conceal espionage or other information gathering activities from normal observers. No saving roll should be required under normal circumstances.

Maintaining such concealment of identity or activities under unusual circumstances (under the scrutiny of an already-suspicious individual, or where particularly dangerous acts must be performed, or in bluffing one's way through a situation requiring talents one does not possess) would require a saving roll against the skill level, with penalties perhaps applied by the gamemaster for especially difficult situations.

This skill is available to characters being created with the basic character creation system for Star Fleet officers, if and only if:

- the character is in the security specialty area
- the character has an INT attribute level of 70 or above, and
- the character is to enter the campaign as a Lt. or above.

Such Star Fleet player characters may not increase this skill level above 20 during the academy years or cadet cruise. Rolls for increases in this skill area during pre-game experience may be made if and only if the character spends at least one year assigned to the military branch of Star Fleet. Any characters not assigned to the military branch during post-academy character generation may not increase this skill as part of rolls resulting from such experience.

SWIMMING AND DIVING: The skill area covers the techniques involved in swimming and diving (not skin or SCUBA diving, but including competition diving). A char-

acter with a minimum skill level of 5 in this area is considered to be able to swim or at least float well enough to survive for a short period of time in water over his/her head without drowning. A minimum skill level of 10 implies the ability to swim as recreation without fear of drowning under normal circumstances.

Those with skill levels in excess of 20 are considered experienced at swimming and diving at the level of an enthusiast. A skill level saving throw in this area may be required to perform some unusual feat of swimming skill, such as rescuing a drowning person, swimming long distances or under adverse conditions such as fast currents or extremely cold water, competing in water athletics, etc.

As an addition to the rules, all graduates of Star Fleet academy are granted a minimum skill level of 5 in this area. All player characters except Vulcans and Caitians may choose this skill as part of the PERSONAL DEVELOPMENT skill tables available for pre-academy experience. (Vulcans come from a dry planet with little free-standing water, and Caitians are not comfortable with swimming or large bodies of water. While both races are capable of learning to swim, it is unlikely they would have learned to do so in early life, if they grew up in their native cultures.)

JACK KATZ - Miner - Age 21 - Human male
 STR 69 END 73 INT 69 DEX 54 CHA 45 LUC 11
 Significant skills: Geology 48
 Ground Veh. Oper. 06
 Mining 13
 Marksmanship (modern) 03
 Pers. Cmbt. (unarmed) 18

LOUIS HANDY - Miner - Age 47 - Human male (deceased)
 STR 61 END 31 INT 52 DEX 58 CHA 16 LUC 17
 PSI 01
 Significant skills: Gaming 03
 Geology 21
 Ground Veh. Oper. 43
 Mining 83
 Pers. Cmbt. (unarmed) 71

RALPH ANTARA - Miner - Age 22 - Human male
 STR 63 END 66 INT 51 DEX 77 CHA 35 LUC 61
 PSI 15
 Significant skills: Geology 51
 Ground Veh. Oper. 15
 Mining 29
 Marksmanship (modern) 38
 Pers. Cmbt. (unarmed) 31

DR. KLAUS WAGNER - Geologist - Age 55 - Human male
 STR 44 END 49 INT 78 DEX 51 CHA 62 LUC 43
 PSI 31
 Significant skills: Geology 79
 Mining 48
 Ground Veh. Oper. 21
 Physical Chemistry 66

TYPICAL JANUS VI MINER (use if you need statistics for a bystander...)
 STR 60 END 65 INT 50 DEX 60 CHA 40 LUC 50
 PSI 10
 Significant skills: Geology 30
 Ground Veh. Oper. 30
 Mining 45
 Marksmanship (modern) 25
 Pers. Cmbt. (unarmed) 35

Janus VI Mining Colony

FLOOR PLAN AND MAP DESCRIPTIONS

The following descriptions can be used by the game-master during the tour of the colony's main building, or if players wish to explore other areas of the station. The gamemaster should be familiar with this information, and you will find it helps to follow along on the maps when reading the descriptions.

MAIN BUILDING

UPPER FOUR LEVELS (above main cavern level, but all underground)

These are living levels, and all four are identical, with one devoted to each shift of workers. (The colony works standard 6 hour shifts, with an arbitrarily selected 24 hour day that has no correlation with the planet's actual period of rotation.) There are 24 miners and technicians living on each level, along with one shift foreman and two members of the administrative staff.

The miners live in shared quarters, two to a room. These suites have a bedroom and living room/study, and each suite shares a bathroom with the suite next door. The rooms are not overly large, but are furnished comfortably.

The living area has a desk equipped with a standard computer terminal. There is also a viewscreen for entertainment programming that folds down from the ceiling when in use. Bedrooms are equipped with wardrobes, and the bathrooms have jacuzzi units.

The foreman of each shift has a private room and bath as part of the benefits of his position. The foremen are working miners themselves, with the added responsibility of overseeing operations during their shift.

The administrative suites are larger private quarters reserved for VIP's, and one is currently occupied by Lt. Solon.

Each living level also has a mess room with automated service. Recognizing the importance of good food to moral in an isolated, small station like this one, the administration has installed the best automated food processing and service equipment available. The equipment here rivals that used aboard Constitution class ships for versatility. The mess rooms are also used for floor meetings and other less formal get-togethers.

ADMINISTRATIVE LEVEL (cavern level)

This level has doors opening onto the floor of the main cavern, giving access to the tunnels themselves. The lobby features a display case containing the very first piece of pergium ore mined at this facility. The case also contains a copy of the company charter and a group hologram of the charter stockholders of the company.

To left and right of the lobby are locker/shower rooms used by the miners when they come in at the end of a shift. Shifts one and three use locker room A while shifts two and four use locker room B.

Moving clockwise around the outer ring of rooms on this level (starting at locker room A), we first come to the

recreation room. This room is equipped with a pool table, table tennis outfit, and a card table and chairs. These are also various other pieces of recreational equipment available here, including chess sets, holographic computer games, etc.

The sales agent's office is often empty, as the sales agent is away from the colony more than half the time arranging the sale of the processed pergium prepared at the Janus VI colony. It is equipped with large viewscreen, computer terminal, and communications equipment. Both the Chief Engineer's office, and that used by his assistant, are served by the reception room between them. All three rooms have a glass wall that offers a spectacular view of the main cavern. The desk in the reception room conceals all of the colony's sophisticated space detection and communication gear, including a subspace radio console. (The actual hardware is in a shielded shelter on the surface, which relays to a set of orbiting satellites.)

The chief engineer's office features an unusual multi-function desk with computer terminal and visicom systems. A small conference table is in one corner, with a wall map in a frame in another corner showing all the main tunnels in the mine. This "map" is a decorative concealment for a viewscreen behind it. A sales chart on the wall near the conference table serves the same purpose. The assistant chief engineer's office is similarly equipped, a mirror image of the office of his superior, though certain details differ.

The other corner office is normally unoccupied, but is kept for VIP guests. It is currently being used by Lt. Solon.

The colony dispensary is almost as well equipped as a Star Fleet sick bay, though not as large. Connected to it is a storage area for medical supplies and the office of the station's lone medical officer.

In the center of this level sits the main geology laboratory and a pergium testing lab. The geology facility is constantly in use, testing samples brought in from all over the mine. The pergium testing facility is only used to spot check for purity when a load of processed pergium is being prepared for shipment.

Part of the pergium testing lab was sectioned off within the last several months and converted into a small transporter facility, feeding a transporter repeater station on the surface of the planet. Before this station was installed, the colony relied on the transport facilities of visiting ships in orbit and the transporter relay alone to travel in and out of the colony. With the new facility, they can more reliably receive transportees from orbit, and now can initiate the transport with no lock-on required from an orbiting ship.

ENGINEERING LEVEL (below cavern level)

On this level are most of the systems that keep the station operating. The central engineering control room contains monitoring equipment for all station engineering functions such as power, life support, etc. This room also contains the main computer banks.

On the opposite side of the turbo lift tube is the fabrication/reclamation facility, containing compact systems for sanitary waste recycling, materials reclamation, recycling of clothing such as mining coveralls, and fabrication machines.

The elevator faces a door leading to the pool and "sun deck". Swimming is a favorite form of recreation and exercise for the miners, and the pool is very popular. A small locker and shower room complex is attached.

Moving clockwise from the pool, we find a large walk-in closet area that serves as a locker for storage of environmental suits (which are almost never used) and the colony's tiny collection of small arms, consisting of about 20 phaser 1 units and 10 phaser 2 handles, with a small recharging unit.

Next is the automated food preparation equipment, which is as sophisticated as that found on some starships. The nearby hydroponics area provides oxygen/carbon dioxide exchange, fresh fruit and vegetables, and flowers! The growing solutions and gro-lites can be monitored from a maintenance panel in this room.

The final room on the periphery of this level is a storage area for small equipment used by the miners, including spare coveralls, etc.

POWER PLANT LEVEL (25 meters below engineering level)

The corridors and storage rooms on this level are of unfinished rough stone. The most important facility on this level is the main reactor room, containing the pump and cooling equipment serving an old model P XK pergium reactor. This room has finished walls, which are reinforced and radiation proofed. Pergium fuel is brought in from the mine and stored in a heavily reinforced storage vault. Automated equipment and a conveyor mechanism fuels the reactor.

Three rough caverns on this level serve for bulk storage, liquid storage, and refrigerated and special food storage, respectively. These caverns are open, with no doors.

MAIN CAVERN FACILITIES

Besides the main living/administrative building, there are a number of other structures on the floor of the main cavern. These are labelled on the detail map of the main cavern, and this section gives some details about each.

Next door to the main building is a large open shed in which the tunnel runner vehicles are kept. Vehicle maintenance is done here as well by miners trained in the necessary skills. If a miner needs to check out a vehicle, he simply punches out on the computer terminal, a process still referred to as "signing out" a vehicle. This is pretty much on the honor system. The colony has 32 tunnel runners and about 20 "sizzle bug" vehicles. There is also a tunnel runner kept in service at this location for the exclusive use of the medical officer. With only 24 miners to a shift, there is almost always a tunnel runner available when one is needed.

Directly north of the main building is a large spherical water storage tank. This water is used and recycled into the

atmosphere in the tunnels and stored until it can be run through the processing plant, which is to the southwest of it.

The pergium processing plant is controlled by a sophisticated computer system (housed in a separate building, to protect the circuits), and is so automated that two men alone usually handle its operation. In a pinch, one man could oversee it for short periods of time. Chemicals used in the processing procedure are stored in nearby tanks.

The five main tunnels leading out of the main cavern are designated sections A, B, C, D and E, in the order in which they were opened. The five sections are now so interconnected that one can go from one section to the other through secondary tunnels without passing through the main cavern.

OTHER AREAS OF INTEREST

THE CHAMBER OF THE AGES

The name for this small cavern comes from a phrase Spock picked up during mind meld with the Horta. It was the original main depository of the Horta "eggs", accidentally opened by the miners. The eggs have since hatched, with the young Hortas removed to an area called "the Playpen".

Although this was by far the largest concentration, the Horta eggs were originally scattered all through this part of the area. About half have hatched so far, with the other half watched over carefully by the mother Horta.

THE PLAYPEN

This cavern was opened and enlarged by the Horta and the miners as a "nursery," for the Horta eggs and the young hatchlings. Once carved out, it was fittled on all sides with force field units like those used on starship brig cells. The units were installed (after some emergency negotiations with a starship that, fortunately, was nearby when the first eggs hatched) to keep the Horta young from wandering into vital or dangerous areas when the adult Horta wasn't around to watch them. There is always one miner assigned here as a guard, with the miners taking rotating three hour shifts. The guard is really assigned as a matter of form, since the equipment is quite safe even were it unattended. The Horta hatchlings are not harmed by the force fields, but are kept in by them. The playpen is large enough to comfortably hold all the hatchlings, even when the rest of the eggs are hatched.

THE HORTA

The following statistics apply to both adult Horta in this adventure, though one is deceased by the time the characters arrive.

STR 100 DEX 50 END 100 INT 65 LUC 40

CHA not applicable PSI 15 AP 8 ARMOR 10 points.

Description: An intelligent silicon being about 7 feet long, 3 feet wide, and covered with mottled asbestos-like plating with multiple short tentacles on the ventral surface. The Horta can burrow through solid rock very quietly and quickly (treat rock like it wasn't even there for purposes of movement) by secreting a powerful molecular corrosive.

The Horta can spit this acid up to 3 meters forward for purposes of self-defense, but will only do so when extremely provoked. The acid does 10D10 of damage per turn until it is neutralized by washing it off, or until 10 turns have passed. Adult horta can guide an acid stream beneath their bodies with enough control to cut small grooves in solid rock like letters or designs.

HORTA HATCHLINGS

STR 30 END 20 DEX 65 INT 30 LUC 40
CHA not applicable PSI 15 AP 9

Armor 2 points (the outer plating is not yet formed...)

Hatchling hortas range from 7 inches long when first hatched to about 3 feet long just before they grow their first set of armor. Their bodies are capable of secreting their corrosive agent from birth, though hatchlings have only about 1.5 meters of range and no fine control. The hatchlings are a mottled grey-brown in color with a rough surface. They are, of course, immune to the effects of their own acid secretion.

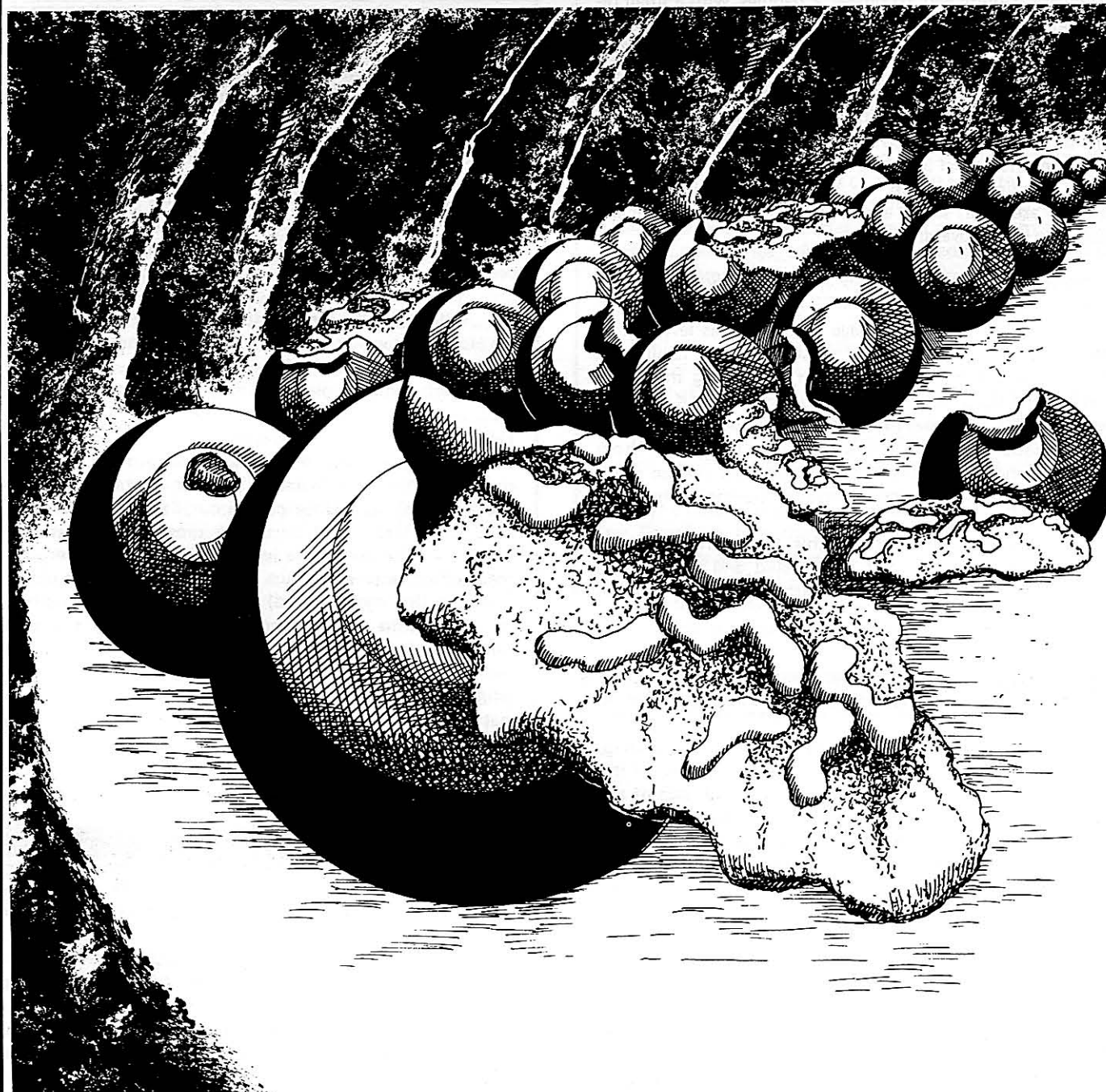

The crew of the Enterprise returns to Janus VI, scene of their adventure with the Horta ("The Devil in the Dark"), and finds tragedy. A young miner stands accused of murder and genocide. Will he be convicted by the swift justice of the final frontier, or can Captain Kirk, Mr. Spock and Dr. McCoy find evidence to clear him? And if they do, where is the real killer, and will he strike again—bringing disaster to the mining colony of Janus VI?

This adventure scenario for **STAR TREK™: The Role Playing Game** contains everything a gamemaster needs to recreate the mystery and excitement of murder on Janus VI. This booklet is designed for use in campaigns featuring the U.S.S. Enterprise crew, and includes complete maps and floor plans for the Janus VI pergium processing facility, which can also be used in later adventures.

